

Panasonic®

Operating Instructions LCD Television Manual de instrucciones Televisor LCD

Model No. **TC-26LX600**
Número de modelo **TC-32LX600**



Customer's Record

The model number and serial number of this product can be found on its back cover. You should note this serial number in the space provided below and retain this book, plus your purchase receipt, as a permanent record of your purchase to aid in identification in the event of theft or loss, and for Warranty Service purposes.

Model Number _____ Serial Number _____

Anotación del cliente

El modelo y el número de serie de este producto se encuentran en su panel posterior. Deberá anotarlos en el espacio provisto a continuación y guardar este manual, más el recibo de su compra, como prueba permanente de su adquisición, para que le sirva de ayuda al identificarlo en el caso de que le sea sustraído o lo pierda, y también para disponer de los servicios que le ofrece la garantía.

Modelo _____ Número de serie _____

Panasonic Consumer Electronics Company,
Division of Panasonic Corporation of North America
One Panasonic Way, Secaucus
New Jersey 07094 U.S.A.

Panasonic Puerto Rico Inc. ("PSC")
Ave. 65 de Infantería, Km 9.5
San Gabriel Industrial Park,
Carolina, Puerto Rico 00985

Panasonic Canada Inc.
5770 Ambler Drive
Mississauga, Ontario
L4W 2T3 CANADA

© 2006 Panasonic Corporation of North America. All Rights Reserved.
© 2006 Panasonic Corporation of North America. Todos los Derechos Reservados.

Printed in U.S.A.
Impreso en EE.UU.



For assistance, please call : 1-800-211-PANA (7262)
or contact us at www.panasonic.com/contactinfo (U.S.A.)

For assistance, please call : 787-750-4300
or visit us at www.panasonic.com (Puerto Rico)

For assistance, please call : 1-800-561-5505
or visit us at www.panasonic.ca (Canada)

Para solicitar ayuda, llame al: 1-800-211-PANA (7262)
o visitenos en www.panasonic.com/contactinfo (EE.UU.)

Para solicitar ayuda, llame al: 787-750-4300
o visitenos en www.panasonic.com (Puerto Rico)

English

Español [Resumen]

Please read these instructions before operating your set and retain them for future reference.
The images shown in this manual are for illustrative purposes only.

Lea estas instrucciones antes de utilizar su televisor y guárdelas para consultarlas en el futuro.
Las imágenes mostradas en este manual tienen solamente fines ilustrativos.

TQB2AA0681-2

Turn your own living room into a movie theater!
Experience an amazing level of multimedia excitement

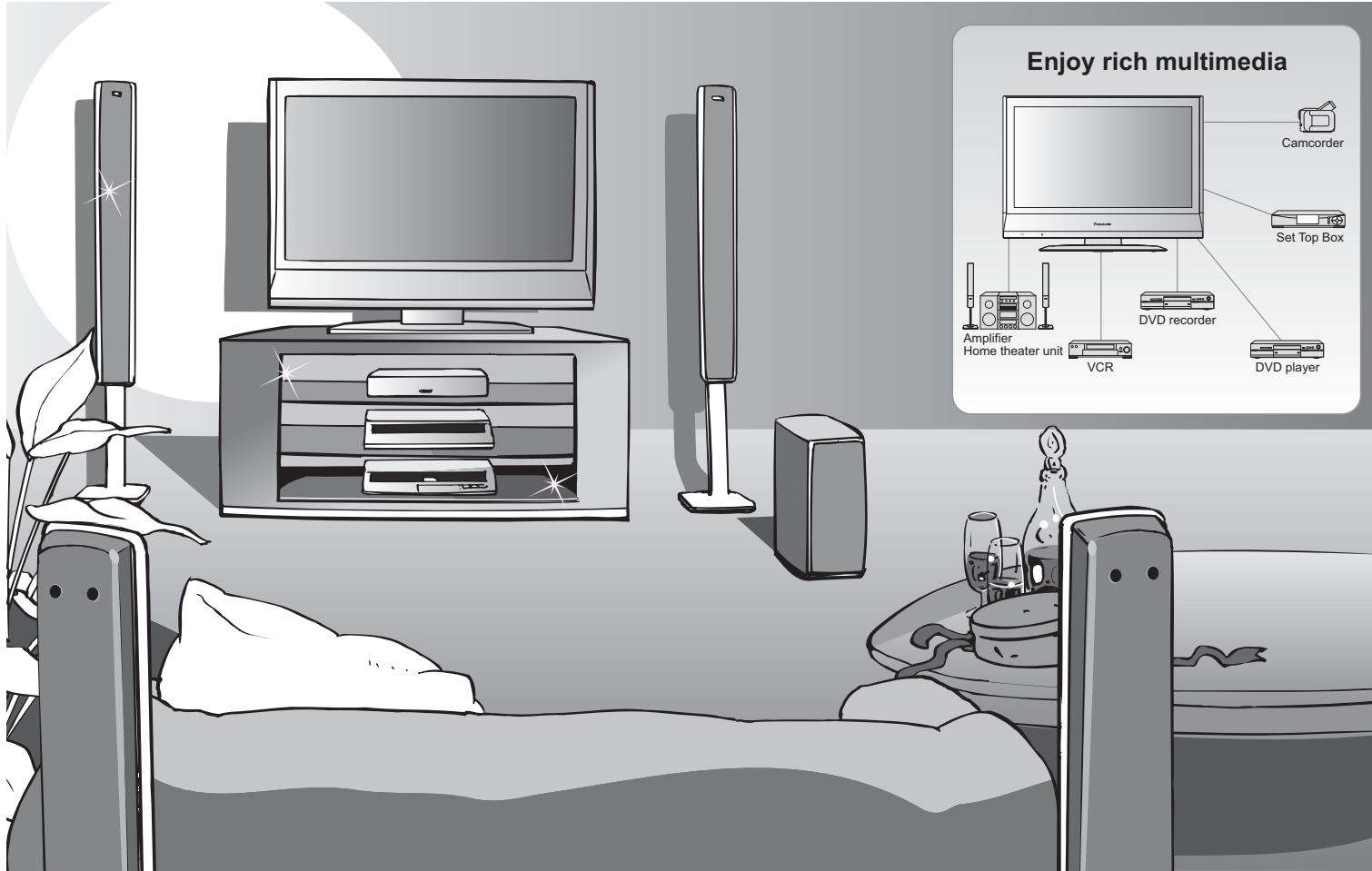

Enjoy rich multimedia

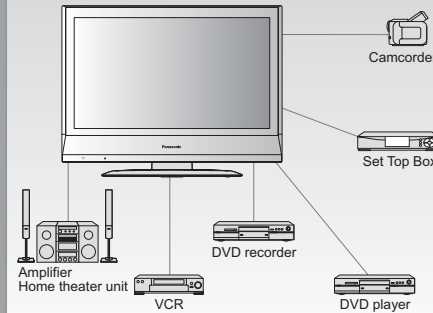

Contents

Please read before using the unit

● Important Safety Instructions 4

● Accessories/Option 6

● **Connection** 7

● Identifying Controls 8

● **First Time Setup** 9

Enjoy your TV !

Basic Features

● Watching TV 10

● Watching Videos and DVDs 12

Advanced Features

● Input Labels/Closed Caption 13

● How to Use Menu Functions (picture, sound quality, etc.) 14

● Channel Lock 16

● Editing and Setting Channels 18

● Operating Peripheral Equipment 20

● Control with HDMI "HDAVI Control™" 21

● Recommended AV Connections 22

● Accesorios/Opción 24

● Conexiones 25

● Identificación de los controles 26

● Ajuste inicial 27

● Para ver la televisión 28

● Cómo utilizar las funciones de los menús 30

● Para ver videos y DVDs 32

● Control con HDMI "HDAVI Control™" 33

● Conexiones AV recomendadas 34

FAQs, etc.

● Remote Control Operation/Code List 36

● Ratings List for Channel Lock 39

● Technical Information 40

● Maintenance 42

● FAQ 43

● Specifications 45

● Limited Warranty (for U.S.A.) 46

● Customer Services Directory (for U. S. A.) 47

● Limited Warranty (for Canada) 48



Manufactured under license from Dolby Laboratories.
"Dolby" and the double-D symbols are trademarks of Dolby Laboratories.



HDMI, the HDMI logo and High-Definition Multimedia Interface are trademarks or registered trademarks of HDMI Licensing LLC.

HDAVI Control™

HDAVI Control™ is a trademark of Matsushita Electric Industrial Co., Ltd.



Important Safety Instructions



CAUTION

RISK OF ELECTRIC SHOCK

DO NOT OPEN



WARNING: To reduce the risk of electric shock, do not remove cover or back. No user-serviceable parts inside. Refer servicing to qualified service personnel.

The lightning flash with arrow head within a triangle is intended to tell the user that parts inside the product are a risk of electric shock to persons.

The exclamation point within a triangle is intended to tell the user that important operating and servicing instructions are in the papers with the appliance.

Note to CATV System Installer

This reminder is provided to direct the CATV system installer's attention to Article 820-40 of the NEC that provides guidelines for proper grounding and, in particular, specifies that the cable ground shall be connected to the grounding system of the building, as close to the point of cable entry as practical.

Secure ventilation

Slots and openings in the cabinet and the back or bottom are provided for ventilation, and to ensure reliable operation of the LCD TV and to protect it from overheating. These openings must not be blocked or covered. There should be at least 10 cm of space from these openings. The openings should never be blocked by placing the LCD TV on a bed, sofa, rug or other similar surface. This LCD TV should not be placed in a built-in installation such as a bookcase unless proper ventilation is provided.

Important Safety Instructions for LCD TV

- 1) Read these instructions.
- 2) Keep these instructions.
- 3) Heed all warnings.
- 4) Follow all instructions.
- 5) Do not use this apparatus near water.
- 6) Clean only with dry cloth.
- 7) Do not block any ventilation openings. Install in accordance with the manufacturer's instructions.
- 8) Do not install near any heat sources such as radiators, heat registers, stoves, or other apparatus (including amplifiers) that produce heat.
- 9) Do not defeat the safety purpose of the polarized or grounding-type plug. A polarized plug has two blades with one wider than the other. A grounding type plug has two blades and a third grounding prong. The wide blade or the third prong are provided for your safety. If the provided plug does not fit into your outlet, consult an electrician for replacement of the obsolete outlet.
- 10) Protect the power cord from being walked on or pinched particularly at plugs, convenience receptacles, and the point where they exit from the apparatus.
- 11) Only use attachments / accessories specified by the manufacturer.
- 12) Use only with the cart, stand, tripod, bracket, or table specified by the manufacturer, or sold with the apparatus. When a cart is used, use caution when moving the cart / apparatus combination to avoid injury from tip-over.
- 13) Unplug this apparatus during lightning storms or when unused for long periods of time.
- 14) Refer all servicing to qualified service personnel. Servicing is required when the apparatus has been damaged in any way, such as power-supply cord or plug is damaged, liquid has been spilled or objects have fallen into the apparatus, the apparatus has been exposed to rain or moisture, does not operate normally, or has been dropped.
- 15) Operate only from the type of power source indicated on the marking label. If you are not sure of the type of power supplied to your home consult your television dealer or local power company.
- 16) Follow all warnings and instructions marked on the LCD TV.
- 17) Never push objects of any kind into this LCD TV through cabinet slots as they may touch dangerous voltage points or short out parts that could result in a fire or electric shock. Never spill liquid of any kind on the LCD TV.
- 18) If an outside antenna is connected to the television equipment, be sure the antenna system is grounded so as to provide some protection against voltage surges and built up static charges. In the U.S. Section 810-21 of the National Electrical Code provides information with respect to proper grounding of the mast and supporting structure, grounding of the lead-in wire to an antenna discharge unit, size of grounding conductors, location of antenna discharge unit, connection to grounding electrodes, and requirements for the grounding electrode.

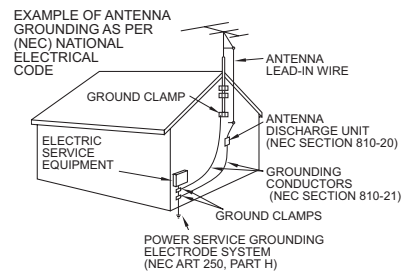

- 19) An outside antenna system should not be located in the vicinity of overhead power lines or other electric light or power circuits, or where it can fall into such power lines or circuits. When installing an outside antenna system extreme care should be taken to keep from touching such power lines or circuits as contact with them might be fatal.
- 20) Unplug this LCD TV from the wall outlet, and refer servicing to qualified service personnel under the following conditions:
 - a. When the power cord or plug is damaged or frayed.
 - b. If liquid has been spilled into the LCD TV.
 - c. If the LCD TV has been exposed to rain or water.
 - d. If the LCD TV does not operate normally by following the operating instructions.

Adjust only those controls that are covered by the operating instructions as improper adjustment of other controls may result in damage and will often require extensive work by a qualified technician to restore the LCD TV to normal operation.
 - e. If the LCD TV has been dropped or the cabinet has been damaged.
 - f. When the LCD TV exhibits a distinct change in performance - this indicates a need for service.
- 21) When replacement parts are required, be sure the service technician uses replacement parts specified by the manufacturer that have the same characteristics as the original parts. Unauthorized substitutions may result in fire, electric shock, or other hazards.
- 22) **WARNING : TO REDUCE THE RISK OF FIRE OR ELECTRIC SHOCK, DO NOT EXPOSE THIS APPARATUS TO RAIN OR MOISTURE. DO NOT PLACE LIQUID CONTAINERS (FLOWER VASES, CUPS, COSMETICS, ETC.) ABOVE THE SET. (INCLUDING ON SHELVES ABOVE, ETC.)**
- 23) **WARNING : SMALL PARTS CAN PRESENT CHOKING HAZARD IF ACCIDENTALLY SWALLOWED. KEEP SMALL PARTS AWAY FROM YOUNG CHILDREN. DISCARD UNNEEDED SMALL PARTS AND OTHER OBJECTS, INCLUDING PACKAGING MATERIALS AND PLASTIC BAGS/SHEETS TO PREVENT THEM FROM BEING PLAYED WITH BY YOUNG CHILDREN, CREATING THE POTENTIAL RISK OF SUFFOCATION.**
- 24) **CAUTION : TO PREVENT ELECTRIC SHOCK DO NOT USE THIS PLUG WITH A RECEPTACLE OR OTHER OUTLET UNLESS THE BLADES CAN BE FULLY INSERTED TO PREVENT BLADE EXPOSURE.**
- 25) **CAUTION : USE WITH OTHER STAND MAY RESULT IN INSTABILITY POSSIBLY CAUSING INJURY.**
- 26) **CAUTION : DANGER OF EXPLOSION IF BATTERY IS INCORRECTLY REPLACED. REPLACE ONLY WITH THE SAME OR EQUIVALENT TYPE.**

NOTE : This equipment is designed to operate in North America and other countries where the broadcasting system and AC house current are exactly the same as in North America.

■ This product utilizes tin-lead solder, and has a fluorescent lamp containing a small amount of mercury. Disposal of these materials may be regulated in your community due to environmental considerations. For disposal or recycling information please contact your local authorities, or the Electronics Industries Alliance: www.eiae.org.

Federal Communication Commission Information

This equipment has been tested and found to comply with the limits for a TV Broadcast Receiver, pursuant to Part 15 of the FCC Rules. These limits are designed to provide reasonable protection against harmful interference in a residential installation. This equipment generates, uses and can radiate radio frequency energy and, if not installed and used in accordance with the instructions, may cause harmful interference to radio communications. However, there is no guarantee that interference will not occur in a particular installation. If this equipment does cause or receive interference, which can be determined by turning equipment off and on, the user is encouraged to try to correct the interference by one or more of the following measures:

- Reorient or relocate the TV antenna.
- Increase the separation between TV and other equipment.
- Connect TV into separate outlet from other equipment.
- Consult the dealer or an experienced radio / TV technician for help.

FCC Caution: Any changes or modifications not expressly approved by the party responsible for compliance could void the user's authority to operate this equipment.

Accessories/Option

✓ Check you have all the items shown.

Accessories

- Remote Control Transmitter
- EUR7613ZF0



- Batteries for the Remote Control Transmitter (2)
- AA Battery



- Operating Instructions
- Product Registration Card (U.S.A.)
- Customer Care Plan Card (U.S.A.)

Installing remote's batteries

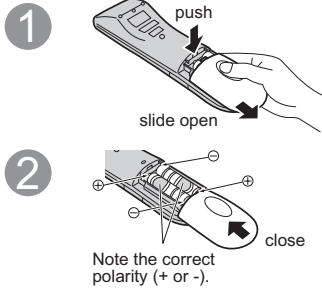

Caution

- Incorrect installation may cause battery leakage and corrosion, resulting in damage to the remote control unit.
- Do not mix old and new batteries.
- Do not mix different battery types (such as alkaline and manganese batteries).
- Do not use rechargeable (Ni-Cd) batteries.
- Do not burn or break batteries.
- Make a note of the remote control codes before changing batteries in case the codes are reset. (p. 37-38)

Optional accessory

Please contact your nearest Panasonic dealer to purchase the recommended wall-hanging bracket. For additional details, please refer to the wall-hanging bracket installation manual.

Wall-hanging bracket (vertical)

- TY-WK32LR2W

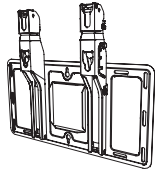

WARNING

- Failure to use a Panasonic bracket or choosing to mount the unit yourself will be done at the risk of the consumer. Any damage resulting from not having a professional installer mount your unit will void your warranty.
- Always be sure to ask a qualified technician to carry out set-up. Incorrect fitting may cause equipment to fall, resulting in injury and product damage.
- Do not mount this LCD Television directly below ceiling lights (such as spotlights, floodlights or halogen lights) which typically give off high heat. Doing so may warp or damage plastic cabinet parts.

How to remove the TV-Stand

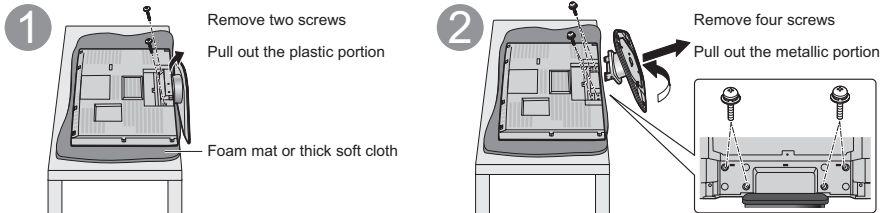

Connection

■ Watching TV

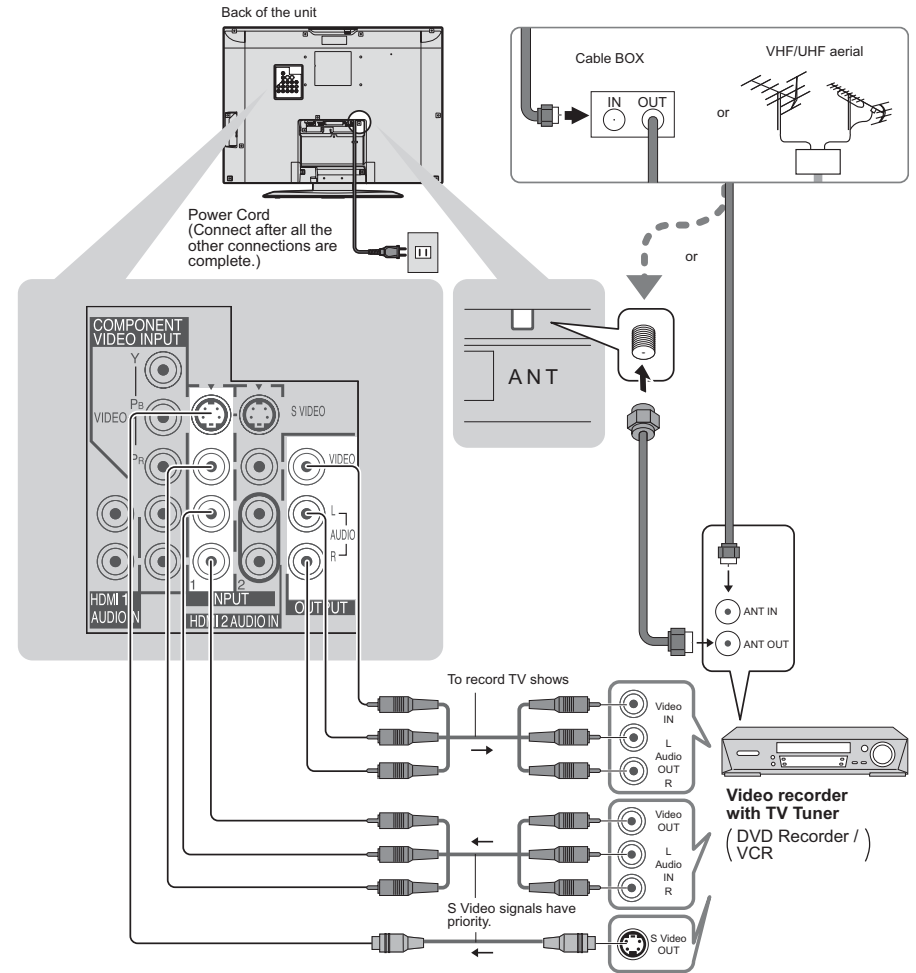

Note

- All cables and external equipment shown in this book are not supplied with the TV.
- For additional assistance, visit us at: www.panasonic.com or www.panasonic.ca
- When connecting video cables, priority is given to the S Video cable when both the S VIDEO input terminal and the VIDEO input terminal are connected.
- When receiving digital channel signals, all digital formats are down-converted to composite NTSC video to be output through "OUTPUT" terminals.
- Some programs contain a copyright protection signal to prevent VCR recording.

Receiver Location

Locate at a comfortable distance for viewing. Avoid placing where sunlight or other bright light (including reflections) will fall on the screen.
Use of some types of fluorescent lighting can reduce remote control transmitter range.
Adequate ventilation is essential to prevent internal component failure. Keep away from areas of excessive heat or moisture.

How to use the LCD stand

Adjust the stand to your desired angle.
The stand angle can be rotated 20° to the right / left.

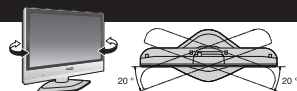

Identifying Controls

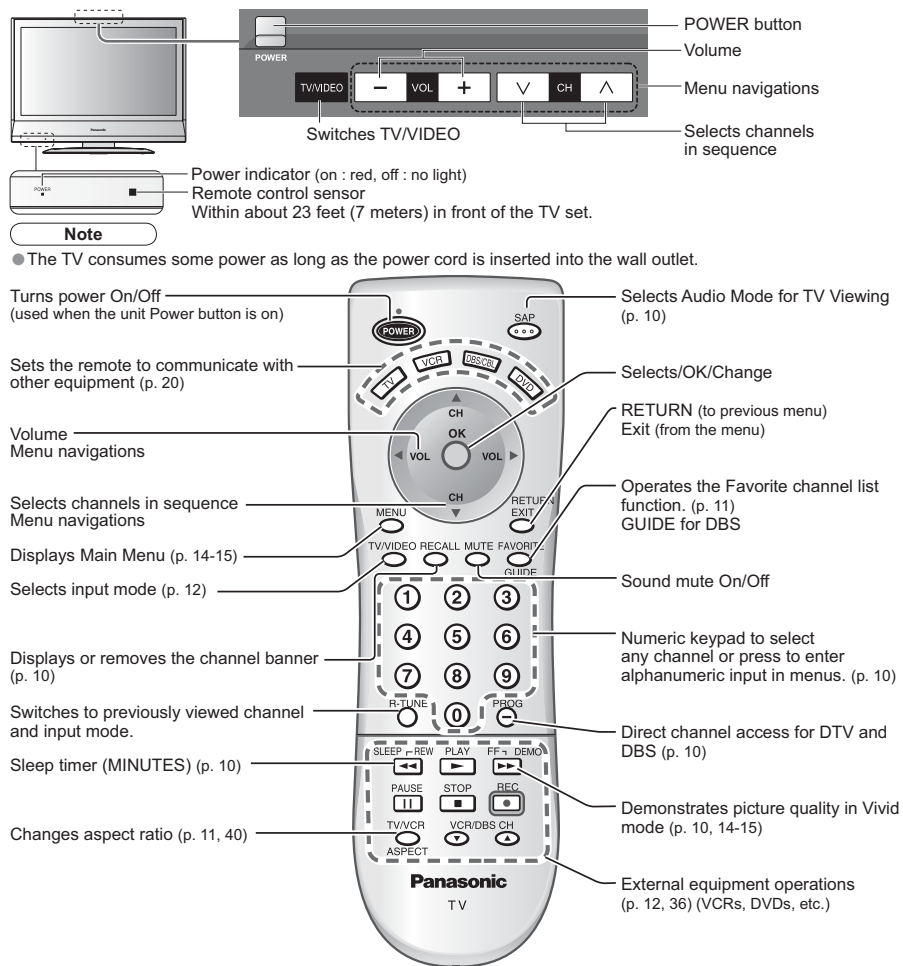

First Time Setup

"First time setup" is displayed only when the TV is turned on for the first time after the power cord is inserted into a wall outlet.

Available only when "Auto power on" (p. 14-15) is set to "Off".

- 1 Turn the TV On with the POWER button**
- 2 Select your language**

English ↔ Español ↔ Français

RETURN EXIT Press to go to previous screen. Or, select icon, then press OK for same results.
- 3 Auto channel setup**

① Select "Auto program"

② Select antenna and input modes

ANT In Cable
Mode All
Start scan

ANT In Cable TV Antenna
Mode All : digital and analog
Analog : analog only (Reduces time for scanning)

- About broadcasting systems
Analog : traditional TV system (NTSC)
Digital : new system that allows you to view (ATSC) more channels featuring high-quality video and sound

③ Start scanning the channels

Now scanning analog channel ...
Progress

Available channels (analog/digital) are automatically set.

④ Confirm registered channels

Favorite Add No Yes
2 Yes

Apply

If OK is not pressed after selecting "Apply", the channels will not be memorized.

■ Press to exit or return to previous screen



Note

- To change setting later, go to Menu screen (p. 14-15)

Watching TV

Connect cable Box when watching cable TV. (p. 7)

● For receiving digital broadcasting of cable TV, connect Cable TV directly to "ANT" terminal.

1 Switch to TV mode
 Press the TV button.

2 Turn power on
 Press the POWER button.

3 Select a channel number
 Use the directional pad (up/down) or the number keys (1-0) to select a channel number.

To directly input the digital channel number
 When tuning digital channel, press the button to enter the minor number in a compound channel number.

example: CH15-1: ① ⑤ ①

■ Other Useful Functions (Operate after ③)

Sleep Timer	<p>Switches the unit OFF in a preset amount of time from 0 to 90 minutes in 30 minute intervals.</p> <p>SLEEP ● 0/30/60/90 (minutes)</p>																		
Picture Demonstrations	<p>FF DEMO</p> <p>on Vivid mode Demo off</p> <p>Demonstrates picture quality in vivid mode (p. 14-15)</p>																		
Listen with SAP (Secondary Audio Program)	<p>■ Selects Audio Mode for TV Viewing</p> <p>SAP </p> <ul style="list-style-type: none"> ● Digital mode Press SAP to select the next audio track (if available) when receiving a digital channel. ● Analog mode Press SAP to select the desired audio mode. • Each press of SAP will change the audio mode. (Stereo/SAP/Mono) 																		
Information Recall	<p>Displays or removes the channel banner.</p> <p>RECALL </p> <table border="1"> <tr> <td>Channel</td> <td>15-2</td> <td>CC</td> <td>SAP</td> <td>TV-G</td> <td>1080i</td> <td>Standard</td> <td>4:3</td> <td>30</td> </tr> <tr> <td>Station identifier</td> <td>ABC - HD</td> <td>Rating Level</td> <td>Signal resolution</td> <td>Picture mode</td> <td>Aspect ratio</td> <td>Sleep timer remaining time</td> <td></td> <td></td> </tr> </table>	Channel	15-2	CC	SAP	TV-G	1080i	Standard	4:3	30	Station identifier	ABC - HD	Rating Level	Signal resolution	Picture mode	Aspect ratio	Sleep timer remaining time		
Channel	15-2	CC	SAP	TV-G	1080i	Standard	4:3	30											
Station identifier	ABC - HD	Rating Level	Signal resolution	Picture mode	Aspect ratio	Sleep timer remaining time													

Change the aspect (p. 40)	<p>TV/VCR ASPECT </p> <ul style="list-style-type: none"> ● Press button to cycle through the aspect modes. • 480i, 480p:FULL/JUST/4:3/ZOOM • 1080i, 720p:FULL/H-FILL/JUST/4:3
Call up a favorite channel	<p>FAVORITE GUIDE </p> <p>■ FAVORITE Channel numbers registered in Favorite are displayed on the favorite tune screen. Select the desired broadcast station with the cursor, or using number keys. (see below)</p>

Note

- Reselect "Cable" or "Antenna" in "ANT In" of "Auto program" to switch the signal reception between cable TV and antenna. (p. 19)
- The channel number and volume level remain the same even after the TV is turned off.

Set Favorite Feature

- Display the channel to be placed on the Favorites list.
- FAVORITE GUIDE

Hold down FAVORITE for several seconds.

 - Press FAVORITE repeatedly to change between pages (1/3, 2/3, 3/3, or exit). Pressing also changes the page.
- select

Press to highlight a position on the list.

Then, press OK to memorize the displayed CH in that position.

 - You can also use the NUMBER keys (1-9 and 0) to select the recorded list numbers (1-9 and 0). By doing so, the numbers will be directly recorded without having to press the OK key.

● **To delete a favorite channel**
 A memorized channel can be removed from the list by holding down FAVORITE while it's position is highlighted.

Use Favorite Feature

- FAVORITE GUIDE

Press FAVORITE.

 - Press FAVORITE repeatedly to change between pages (1/3, 2/3, 3/3, or exit). Pressing also changes the page.
- select

Press or a Numbered key (1-9 and 0) to highlight a channel on the list.

 - Selecting a channel number from the list with the Number keys will display the channel directly.
- ok

Press OK to display the highlighted channel.

Watching Videos and DVDs

Some Panasonic equipment connected to the TV unit can be operated with the remote control. Programming the remote control is necessary to operate other manufacturers' products. (p. 20, 36-38)

1 With VCR or DVD turned On
Switch to external input
Press to display the Input select menu.
TV/VIDEO

2 **Select the input mode**

Input select

- [1] TV
- [2] Component
- [3] HDMI 1
- [4] HDMI 2
- [5] Video 1
- [6] Video 2
- [7] Video 3

Press corresponding NUMBER key on the Remote Control to select the input of your choice.

or

Press to select the input of your choice, then press "OK".

- If during selection, no action is taken for several seconds, the Input selection menu is exited.

3 **Operate**
the VCR or DVD with the remote control

■ Press to return to TV TV/VIDEO

● The terminal and label of the connected equipment is indicated. To label each of the connected equipment (p. 13)

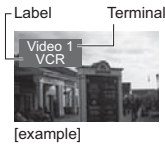

Note

● For details, see the manual of the equipment or ask your local dealer.

	VCR	DVD
SLEEP DEMO	Rewind/Fast Forward	Reverse/Forward
PLAY	Play	Play
PAUSE	Pause	Pause
STOP	Stop	Stop
REC	VCR Record	—
TV/VCR ASPECT	TV/VCR	Open/Close
VCR/DBS CH	Channel Down/UP	Slow Reverse/Forward

(For other operations, see p. 36)

Input Labels/Closed Caption

1 **Display menu**
MENU

2 **Select "Setup"**

3 **Select "Input labels" or "CC"**

4 **Set** ■ Press to exit RETURN EXIT

The labels of equipment connected to external input terminals can be indicated for easy recognition on the screen. (In selecting input mode of p. 12 ●)

Select the terminal and the label of the external equipment

Input labels

Comp.	SKIP	Label	Terminal
HDMI 1	DVD		
HDMI 2	SKIP		
Video 1	AUX		
Video 2	SKIP		
Video 3	SKIP		

● Terminal: Comp./HDMI1-2/Video1-3
● Label: SKIP*/VCR/DVD/CABLE/DBS/PVR/ GAME/AUX/[BLANK]

* If "SKIP" is selected for a non-connected terminal, its input is skipped when switched with TV/VIDEO button.

[example]

The television includes a built-in decoder that is capable of providing a text display of the audio. The program being viewed must be transmitting Closed Captioning (CC) information. (p. 40)

Select the item and set

CC

Mode	Off	Mode	Select "On" (when not using, select "Off").
Analog	CC1	Analog	(Choose the closed caption service of Analog broadcasting.)
Digital setting	Primary	CC1-4:	Information related to pictures (Appears at bottom of screen)
CC reset		T1-4:	Textual information (Appears over entire screen)

● The settings in "Analog" or "Digital" depend on the broadcaster.

Digital

(The Digital Closed Caption menu lets you configure the way you choose to view the digital captioning.)

Select the setting.

- "Primary", "Second.", "Service 3", "Service 4", "Service 5", "Service 6"

To make more in-depth display settings in digital programs

① Select "Digital setting" and press "OK" button ② Select the item and set

Digital setting

Size	Automatic	● Size: Text size
Font	Automatic	● Font: Text font
Style	Automatic	● Style: Text style (Raised, Depressed, etc.)
		● Foreground: Color of text
		● Fore opacity: Opacity of text
		● Background: Color of text box
		● Back opacity: Opacity of text box
		● Outline: Outline color of text (Identify the setting options on the screen.)

(1/3)

To reset the settings

Select "CC reset" and press "OK" button

How to Use Menu Functions

Various menus allow you to select settings for the picture, sound, and other functions so that you can enjoy watching TV with your preferences set.

1 Display menu
 MENU ● Displays the functions that can be set (varies according to the input signal)

2 Select the menu
 Menu
 Picture
 Audio
 Timer
 Lock
 Setup

3 Select the item
 Picture 1/2
 Normal Set
 Pic. mode Standard
 Back light +20
 Picture +20
 Brightness 0
 Color 0
 Tint 0
 Sharpness 0
 (example: Picture menu)

4 Adjust or select
 Picture 1/2
 Normal Set
 Pic. mode Standard
 Back light +20
 Picture +20
 Brightness 0
 Color 0
 Tint 0
 Sharpness 0
 (example: Picture menu)

■ Press to exit or return to previous screen
 RETURN
 EXIT

Menu list		
Menu	Item	
Picture	Normal	
	Pic. mode	
	Back light	
	Picture, Brightness, Color, Tint, Sharpness	
	Color temp	
	Vivid mode	
	AI picture	
	Zoom adjust	
	Other adjust	Video NR
		3D Y/C filter
Color matrix		
Black level		
Audio	Normal	
	Bass	
	Treble	
	Balance	
	Other adjust	AI sound
		Surround
HDMI1 in, HDMI2 in		
Audio leveler		
Timer	Sleep	
Lock		
Setup	CH scan	
	Language	
	Program channel	
	Input labels	
	CC	
	Other adjust	Auto power on
		Prog-out stop
		Ctrl with HDMI
		Power save
	About	
Reset		

Adjustments/Configurations (alternatives)		
Resets all picture adjustments to factory default settings except for "Other adjust"	Normal	Set
Basic picture mode (Vivid/Standard/Cinema) (p. 41)	Pic. mode	Standard
Adjusts luminance of the back light.	Back light	+20
Adjusts color, brightness, etc. for each picture mode to suit your taste	Picture Brightness Color	+20 0 0
Adjusts color, brightness, etc. for each picture mode to suit your taste	Tint Sharpness	0 0
Selects level of warm colors (red) and cool colors (blue) (Warm/Cool/Normal)	Color temp	Cool
Enhances green and blue color reproduction, especially outdoor scenes. (On/Off)	Vivid mode	Off
Controls dark areas without affecting the black level or brightness in the overall picture (On/Off)	AI picture	On
Adjusts vertical alignment and size when aspect setting is "ZOOM" (p. 40)	Zoom adjust	
Reduces noise, commonly called snow. Leave off when receiving a strong signal. (On/Off)	Video NR	Off
Minimizes noise and cross-color in the picture. (On/Off)	3D Y/C filter	Off
Selects image resolution of component-connected devices (SD/HD)	Color matrix	SD
● SD: normal vision HD: high-definition vision ● Only 480 p signal accepted; regular TV (NTSC) is not available.	Black level	Light
Select Dark or Light depending on the picture conditions. (Dark/Light) The dark scene becomes easy to see. (Valid only for external input signals.)	Reset Bass, Treble and Balance adjustments to factory default settings.	Normal Set
Reset Bass, Treble and Balance adjustments to factory default settings.	Increase or decrease the bass response.	Bass +4
Increase or decrease the bass response.	Increase or decrease the treble response.	Treble 0
Increase or decrease the treble response.	Emphasize the left / right speaker volume.	Balance 0
Emphasize the left / right speaker volume.	Equalize overall volume levels across all channels and VIDEO inputs. (On/Off)	AI sound On
Equalize overall volume levels across all channels and VIDEO inputs. (On/Off)	Enhances audio response when listening to stereo. (On/Off)	Surround Off
Enhances audio response when listening to stereo. (On/Off)	Selects according to the signal when HDMI is connected (Auto/Digital/Analog)	HDMI1 in Auto
Selects according to the signal when HDMI is connected (Auto/Digital/Analog)	● Auto: Automatically selects Analog / Digital signal	Audio leveler 0
Minimizes volume disparity after switching to external inputs	Automatically turns off the TV after a pre-selected amount of time. ● 0/30/60/90 (minutes) Timer setting is also possible by pressing the "Sleep" button on the remote control. (p. 10)	Sleep 60
Automatically turns off the TV after a pre-selected amount of time. ● 0/30/60/90 (minutes) Timer setting is also possible by pressing the "Sleep" button on the remote control. (p. 10)	Locks the channels and programs (p. 16-17)	
Locks the channels and programs (p. 16-17)	Selects channels to be displayed when pressing "Channel up/down" buttons. (Fav./All)	CH scan All
Selects channels to be displayed when pressing "Channel up/down" buttons. (Fav./All)	● Fav.: Only channels registered as Favorite (p. 19)	Language
● Fav.: Only channels registered as Favorite (p. 19)	Selects the screen menu language (p. 9)	Program channel
Selects the screen menu language (p. 9)	Sets receiving channels. (p. 18-19)	Input labels
Sets receiving channels. (p. 18-19)	Displays labels of external equipment (p. 13)	CC
Displays labels of external equipment (p. 13)	Displays subtitles (Closed Caption) (p. 13)	
Displays subtitles (Closed Caption) (p. 13)	Sets how to power on the TV. (Set/Off) Set : Connect power cord plug to Cable box etc. and control TV's On/Off on the connected equipment. (The Sleep Timer will not function if Auto power on is set.) Off : Supply Power from wall outlet and control TV's On/Off on TV side. ("First time setup" menu is displayed when power cord plug is re-inserted after removing it from the wall outlet.)	Auto power on Off
Sets how to power on the TV. (Set/Off) Set : Connect power cord plug to Cable box etc. and control TV's On/Off on the connected equipment. (The Sleep Timer will not function if Auto power on is set.) Off : Supply Power from wall outlet and control TV's On/Off on TV side. ("First time setup" menu is displayed when power cord plug is re-inserted after removing it from the wall outlet.)	To prevent howling and image oscillation, stops output of the pictures and audio specified in this menu. (p. 23) (Off/Comp./HDMI 1/HDMI 2/Video 1/Video 2/Video 3) ● Comp./HDMI 1/HDMI 2 cannot output video signals regardless of "Prog-out stop" setting.	Prog-out stop Off
To prevent howling and image oscillation, stops output of the pictures and audio specified in this menu. (p. 23) (Off/Comp./HDMI 1/HDMI 2/Video 1/Video 2/Video 3) ● Comp./HDMI 1/HDMI 2 cannot output video signals regardless of "Prog-out stop" setting.	Controls equipment connected to HDMI terminals. (p. 21, 22) (On/Off)	Ctrl with HDMI On
Controls equipment connected to HDMI terminals. (p. 21, 22) (On/Off)	Reduces screen brightness to lower power consumption. Eye-friendly for viewing in a dark room (Standard/Saving)	Power save Standard
Reduces screen brightness to lower power consumption. Eye-friendly for viewing in a dark room (Standard/Saving)	Displays TV version and software license.	About
Displays TV version and software license.	Performing Reset will clear all items set with Setup, such as channel settings. (p. 18) Use Reset with care.	Reset
Performing Reset will clear all items set with Setup, such as channel settings. (p. 18) Use Reset with care.		

● In VIDEO mode, the Audio menu and Setup menu give a smaller number of options.

Channel Lock

You can lock out specified channels or shows to prevent children from watching objectionable content.

1 Display menu
MENU

2 Select "Lock"
You will be asked to enter your password each time you display the Lock menu.

3 Input your 4-digit password
A 4-digit code must be entered to view a blocked program or change rating settings.

4 Select the Lock mode

Press to exit



Caution

- Make a note of your password in case you forget it. (If you have forgotten your password, consult your local dealer.)

Note

- When you select a locked channel, a message will be displayed that allows you to view the channel if you input your password.

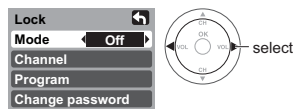
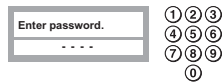
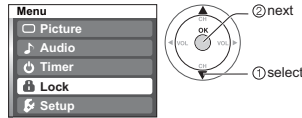

- Off: "Channel lock" not activated
- All: Locks all channels and external inputs
- Game: Locks CH3, CH4, and external inputs
- CH: Locks specified channels (analog/digital)

To change the password

- ① In ③, select "Change password" and press "OK" button
- ② Input the new 4-digit password twice

To cancel the "Channel lock"

- ④ Select "Off" in ④

To select the channel or the rating of the program to be locked

Channel Lock

Select up to 7 (1-7) channels to be blocked out. These channels will be blocked out regardless of the program rating.

Select "CH" in ④

① Select "Channel"

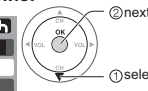
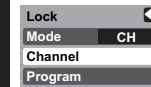

② Select channel to lock

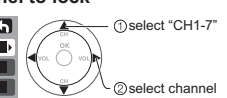
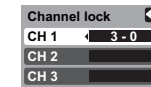

To set rating level

"V-chip" technology enables restricted shows to be locked according to TV ratings.

① Select "Program"

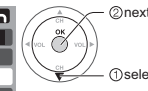
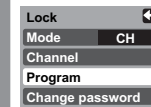

② Select the rating category you wish to follow

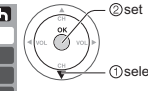
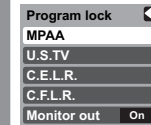

- MPAA: U.S movie ratings
- U.S.TV: U.S TV program ratings
- C.E.L.R.: Canadian English ratings
- C.F.L.R.: Canadian French ratings

To disable recording of the locked program

- ➔ Select "Monitor out" in "Program lock" menu (②)

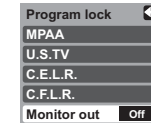

- On : Turns on the monitor terminal output for programs that have been set to "Blocked."
- Off : Turns off the monitor terminal output for programs that have been set to "Blocked."

③ Select the rating to be locked

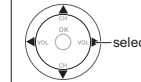

Example of "MPAA" (U.S movie ratings)

Rating	Description
Off	No rating
G	General Audience: All ages admitted
PG	Parental Guidance Suggested
PG-13	Parents Strongly Cautioned: Inappropriate for children under 13
R	Restricted: Under 17 requires accompanying parent or adult guardian
NC-17	No one 17 and under admitted
X	Adults only

- To get other information (p. 39)

Block program

Caution

- The V-Chip system that is used in this set is capable of blocking "NR" programs (non rated, not applicable and none) as per FCC Rules Section 15.120(e)(2). If the option of blocking "NR" programs is chosen "unexpected and possibly confusing results may occur, and you may not receive emergency bulletins or any of the following types of programming:"
 - Emergency Bulletins (Such as EAS messages, weather warnings and others)
 - Locally originated programming • News • Political • Public Service Announcements • Religious • Sports • Weather

Note

- The Off rating is independent of other ratings.
- When placing a block on a specific age based rating level, the Off rating and any other more restrictive ratings will also be blocked.

Editing and Setting Channels

The current channel settings can be changed according to your needs and reception conditions.

- 1 Display menu**
MENU
- 2 Select "Setup"**
Menu
Picture
Audio
Timer
Lock
Setup
- 3 Select "Program channel"**
Setup
CH scan ALL
Language
Program channel
Input labels
CC
Other adjust
- 4 Select the function**
Program channel
Auto
Manual
Signal meter

■ Press to exit
RETURN
EXIT

Auto
Set automatically

Manual
Set manually

Signal meter
Check signal strength

Automatically searches and adds active channels to memory.

① Select "ANT In" → (Select Cable or Antenna)
② Select "Mode" → Select All or Analog
All: Analog and digital
Analog: Analog only

③ Select "Start scan"

Settings are made automatically

- After completing the setting, select "Apply". (see below ④).
- All previously memorized channels are erased.

Use this procedure when changing setting of receiving channels or changing the channel display. Also, use to add or delete channels from channel list manually.

① Select "Edit"

② Select the item to be edited
(Caption/Favorite/Add)

③ Edit

- **Caption**
Caption select
Preset
Caption detail
Preset
Select the station identifier
Caption detail
Rename (maximum 7 characters available)
- **Favorite**
Favorite
Favorite
Select the number
- **Add**
Press "OK" button to select "Yes (add)" or "No (delete)"

④ Select "Apply"

Press to move cursor to "Apply"

Check the signal strength if interference is found or freezing occurs on a digital image.

● If the signal is weak, check the antenna. If no problem is found, consult your local dealer.

Note

- Not available if "Cable" is selected in "ANT In" (see above).
- Effective only for digital antenna channels.

● If "Channel lock" (p. 16) is activated and "Auto", "Manual" or "Signal meter" is selected, "Enter password." will be displayed.

Operating Peripheral Equipment

You can operate other manufacturers' equipment using this TV's remote control.

- 1** Connect the external equipment to the TV and **Power Off the external equipment**
- 2** **Press both buttons simultaneously for more than 3 seconds.**
 - Release the buttons when the equipment selection buttons start flashing.
- 3** **Select the equipment** with the equipment selection button
 - The selected button remains lit (other buttons are not lit).
- 4** **Input the equipment's 4-digit remote control code** (p. 37-38)
- 5** **Operate the equipment with the remote control** (p. 36)
 - The external equipment turns On.

■ If the equipment does not operate with remote control

- When your equipment has a single code
 - ➔ Input the remote control code again
- When your equipment has multiple codes
 - ➔ Change the code with 4 above and test again

Caution

- Registration will fail if the wrong code is input or it takes more than 30 seconds to register.

To find a code not listed in the code list

This procedure searches all codes and is called the "sequence method."

① **After step ③ above, change the code and test**



➔ Operate the equipment with the remote control (p. 36)

- Repeat until the code is found
- It may take many attempts before the correct code is found

② **When the correct code is found**



Control with HDMI "HDAVI Control™"

Newer Panasonic audio-video products with HDMI output connections can be controlled using the TV's remote. Limited features such as automatic switching to the TV's HDMI input are available.

- This feature is limited to models incorporating Panasonic's "Control with HDMI". Refer to the individual instruction manuals for compatibility information.
- Non-HDMI-compliant cables cannot be utilized.
- It is recommended that you use Panasonic's HDMI cable.
 - Recommended part number: RP-CDHG15 (1.5 m)
 - RP-CDHG30 (3.0 m)
 - RP-CDHG50 (5.0 m)

Automatic input switching

When "Ctrl with HDMI" is set to "On", at the start of HDAVI control compatible equipment's playback, the TV's input automatically switches to the input corresponding to the playback equipment.

- If using DIGA operation, the TV's input automatically switches to DIGA and the DIGA menu is displayed. If the TV's power is Off, it is automatically switched On.

Power on link

When "Ctrl with HDMI" is set to "On", the TV is automatically turned on and switched to the appropriate HDMI input whenever HDAVI control compatible equipment is initially turned on and Play mode is selected.

Power off link

When "Ctrl with HDMI" is set to "On" and the TV is turned off, the connected HDAVI control compatible equipment is also automatically turned off.

- DIGA (Panasonic DVD Recorder) will not turn off if it is still in rec mode.

Caution

- The TV remains on even if the "Control with HDMI" compatible equipment is turned off.

Note

- Before using HDMI control functions, the connected equipment must also be set. For details, see the operation manual for each equipment.
- For equipment connection details, see p. 22.
- Default setting is "On". If no HDMI equipment is connected or standard HDMI equipment (non- "Control with HDMI") is used, set to "Off". (see below)

- 1** **Display menu**
MENU
- 2** **Select "Setup"**
Menu
Picture
Audio
Timer
Lock
Setup
- 3** **Select "Other adjust"**
Setup
CH scan ALL
Language
Program channel
Input labels
CC
Other adjust
- 4** **Select "Ctrl with HDMI"**
Other adjust
Auto power on Off
Prog-out stop Off
Ctrl with HDMI On
Power save Standard
- 5** **Select "On" or "Off"**

■ Press to exit or return to previous screen

➔ RETURN
EXIT

Recommended AV Connections

These diagrams show our recommendations for how to connect the TV unit to your various equipment.
 For other connections, consult the instructions of each equipment and the specifications (p. 45).
 For additional assistance, please visit our website at: www.panasonic.com
www.panasonic.ca

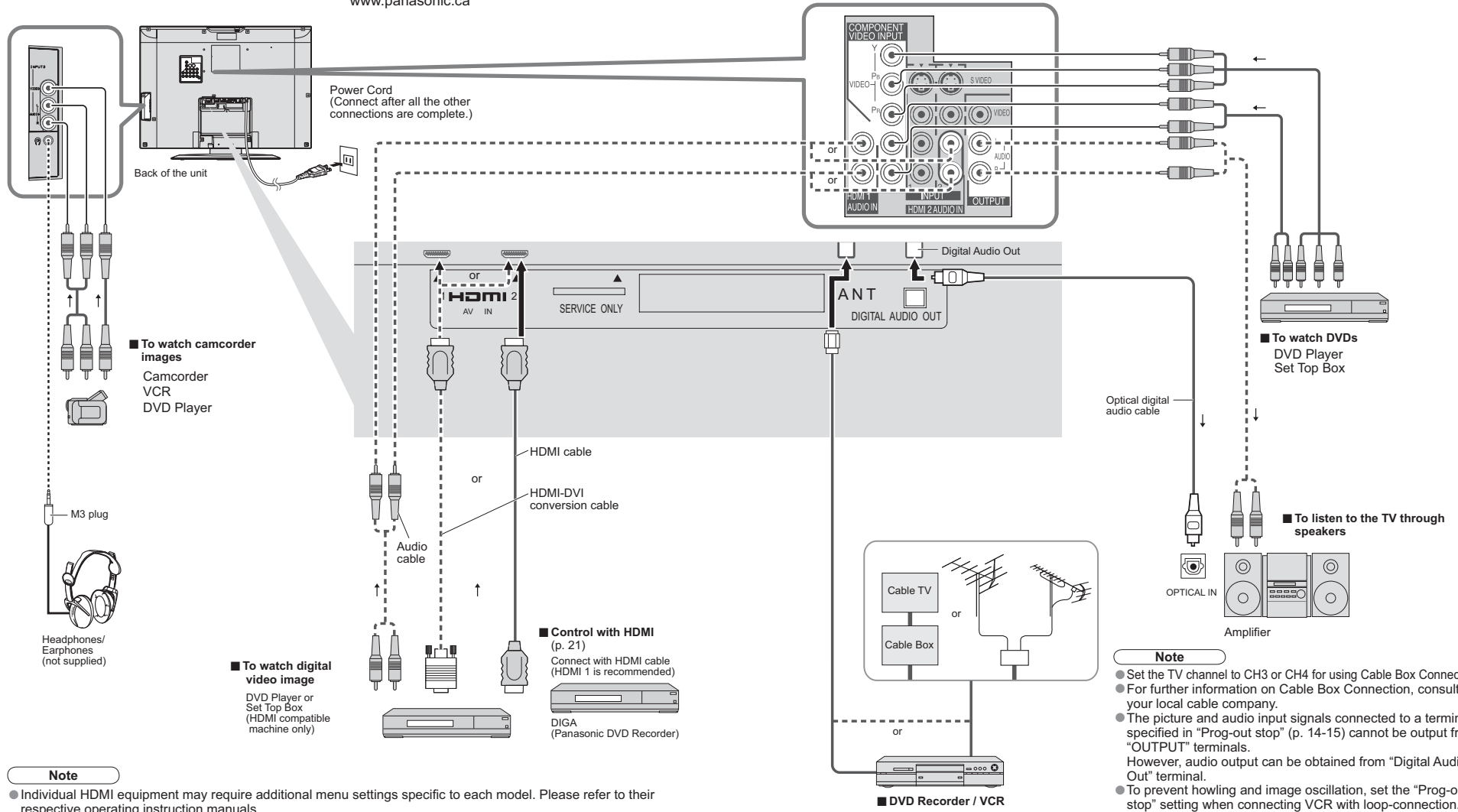

- Note**
- Individual HDMI equipment may require additional menu settings specific to each model. Please refer to their respective operating instruction manuals.
 - When connecting to HDMI 2, set the input mode to HDMI 2 (p. 12) initially before connecting to HDMI 2. After connection, confirm the HDMI control functions (p. 21).

- Note**
- Set the TV channel to CH3 or CH4 for using Cable Box Connection.
 - For further information on Cable Box Connection, consult to your local cable company.
 - The picture and audio input signals connected to a terminal specified in "Prog-out stop" (p. 14-15) cannot be output from "OUTPUT" terminals. However, audio output can be obtained from "Digital Audio Out" terminal.
 - To prevent howling and image oscillation, set the "Prog-out stop" setting when connecting VCR with loop-connection. (p. 14)
 - When equipment (STB, DVD, etc.) is connected to HDMI or COMPONENT terminals, only audio signals can be obtained. No video signals can be output.

Accesorios/Opción

✓ Compruebe que ha recibido todos los elementos que se indican.

Accesorios

- Transmisor de mando a distancia
● EUR7613ZF0
- Pilas para el transmisor de mando a distancia (2)
● Pila AA
- Manual de instrucciones
- Tarjeta del cliente (para EE. UU.)
- Tarjeta para el plan de asistencia al cliente (para EE. UU.)

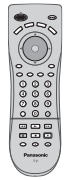

Instalación de las pilas del mando a distancia

1

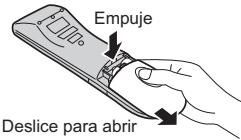

Empuje

Deslice para abrir

2

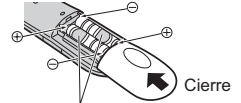

Cierre

Ponga las polaridades (+ ó -) en las posiciones correctas

Precaución

- La instalación mal hecha puede causar fugas de electrolito y corrosión, lo que podría dañar el mando a distancia.
- No mezcle pilas viejas y nuevas.
- No mezcle pilas de tipos diferentes (pilas alcalinas y de manganeso, por ejemplo).
- No utilice baterías (Ni-Cd).
- No queme ni rompa las pilas.
- Anote los códigos de mando a distancia antes de cambiar las pilas en el caso de que tenga que restablecer los códigos. (págs. 37-38)

Accesorio opcional

Póngase en contacto con su concesionario Panasonic más cercano para adquirir la ménsula de montaje en pared recomendada. Para conocer más detalles, consulte el manual de instalación de la ménsula de montaje en pared.

Soporte para colgar en pared (vertical)
● TY-WK32LR2W

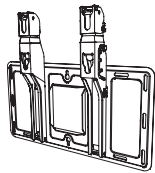

ADVERTENCIA

- No utilizar una ménsula de Panasonic ó montar la unidad usted mismo puede ser la causa de que el consumidor corra riesgos. Cualquier daño que resulte de no haber sido un instalador profesional quien montó su unidad anulará su garantía.
- Asegúrese de pedir siempre a un técnico calificado que lleve a cabo la instalación. Una instalación incorrecta podría ser la causa de que el equipo cayera, causando lesiones a personas y daños en el producto.
- No monte el televisor LCD directamente debajo de las luces del techo (luces direccionales, reflectores ó luces halógenas) que producen típicamente mucho calor. De lo contrario podrían deformarse ó dañarse las piezas de plástico de la caja.

Cómo retirar la base del televisor

1

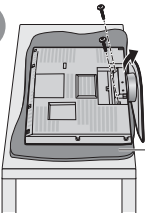

Retire dos tornillos.

Saque la parte de plástico.

Estera de espuma ó paño blanco y grueso

2

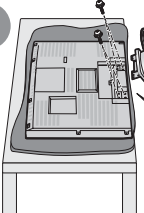

Retire cuatro tornillos.

Saque la parte metálica.

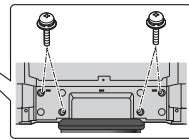

Conexiones

■ Para ver la televisión

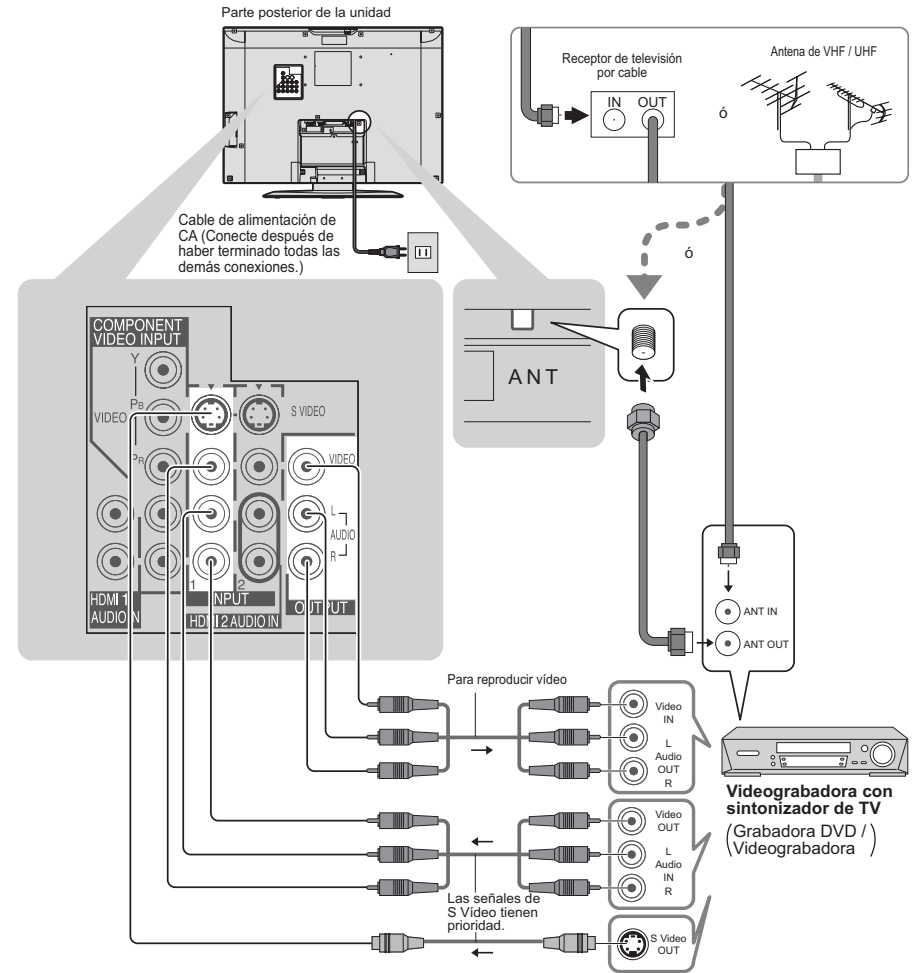

Notas

- Con este televisor no se suministran todos los cables ni equipos externos mostrados en este manual.
- Para obtener más ayuda, visítenos en www.panasonic.com
- Al conectar cables de video se da prioridad al cable de S video cuando están conectados el terminal de entrada S VIDEO y el terminal de entrada VIDEO.
- Cuando reciba señales de canales digitales, todos los formatos digitales serán convertidos en sentido descendente en video NTSC compuesto que saldrá a través de los terminales de salida de programas.
- Algunos programas contienen una señal de protección de derechos de autor para impedir la grabación con una videograbadora.

Colocación del receptor

Coloque el receptor a una distancia confortable para ver. Evite colocarlo donde la luz solar directa u otra luz brillante (incluidos reflejos) caiga sobre la pantalla.

La utilización de algún tipo de iluminación fluorescente puede reducir el alcance del transmisor del mando a distancia.

La ventilación adecuada es esencial para impedir el fallo de los componentes internos. Manténgase alejado de las áreas donde el calor o la humedad sea excesivo.

Cómo utilizar la base del LCD

Ajuste el soporte con el ángulo deseado

El ángulo del soporte se puede girar 20° hacia la derecha/izquierda.

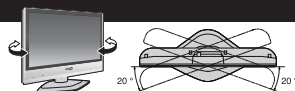

Identificación de los controles

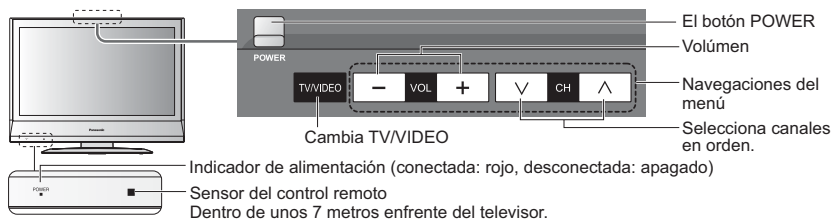

Nota

● El televisor consumirá algo de corriente siempre que el enchufe del cable de alimentación esté introducido en la toma de corriente.

Conecta/desconecta la alimentación. (Se utiliza cuando está activado el botón de la alimentación.)

Configura el mando a distancia para hacer la comunicación con otros dispositivos.

Volúmen
Navegaciones del menú

Selecciona canales en orden.
Navegaciones del menú

Visualiza el menú principal. (págs. 30-31)

Selecciona el modo de entrada. (pág. 32)

Visualiza ó elimina la bandera de canal. (pág. 28)

Cambia al canal visto previamente.

Temporizador para acostarse (MINUTOS) (pág. 28)

Cambia la relación de aspecto (pág. 29)

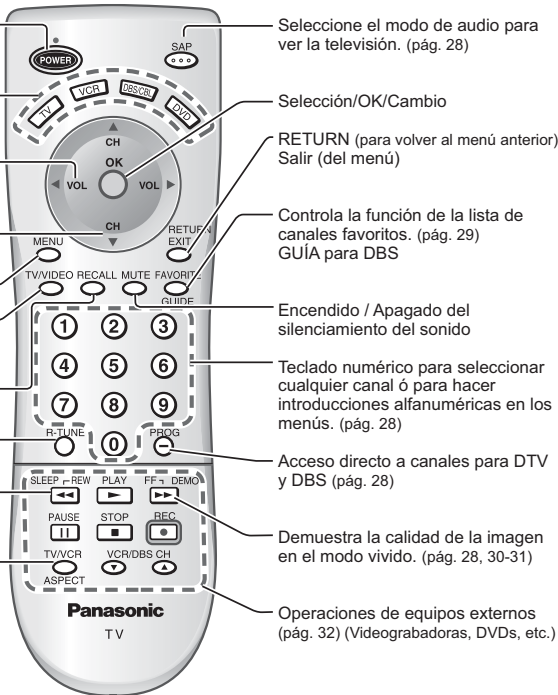

Seleccione el modo de audio para ver la televisión. (pág. 28)

Selección/OK/Cambio

RETURN (para volver al menú anterior)
Salir (del menú)

Controla la función de la lista de canales favoritos. (pág. 29)
GUÍA para DBS

Encendido / Apagado del silenciamiento del sonido

Teclado numérico para seleccionar cualquier canal ó para hacer introducciones alfanuméricas en los menús. (pág. 28)

Acceso directo a canales para DTV y DBS (pág. 28)

Demuestra la calidad de la imagen en el modo vivo. (pág. 28, 30-31)

Operaciones de equipos externos (pág. 32) (Videograbadoras, DVDs, etc.)

Ajuste inicial

“Ajuste inicial” sólo se visualiza cuando el televisor se enciende por primera vez después de conectar el cable de alimentación de CA en una toma de corriente.

Sólo disponible cuando “Autoencendido” (págs. 30-31) está en “Sí”.

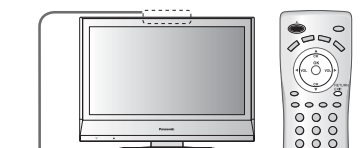

1 Encienda el televisor con el interruptor POWER.



2 Seleccione su idioma.

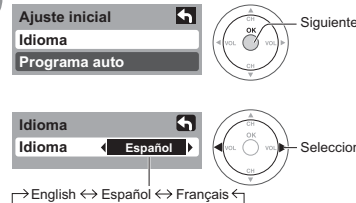

RETURN EXIT
Pulse para ir a la pantalla anterior ó seleccionar un icono, y luego pulse OK para obtener el mismo resultado.

3 Configuración automática de canales

1 Seleccione “Programa auto”.



2 Seleccione la antena y los modos de entrada

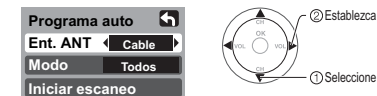

Ent. ANT Cable Antena: Antena

Modo Todos
Todos : Digital y analógico
Análogo: Analógico solamente (Reduce el tiempo para la recepción)

● Acerca de los sistemas de emisión
Análogo : Sistema de televisión tradicional (NTSC)
Digital : Un sistema nuevo que le permite ver más canales con imagen y sonido de alta calidad.

3 Inicie la exploración de los canales.

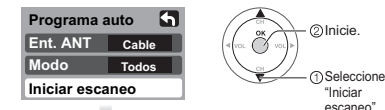

● Los canales disponibles (analógicos/digitales) se establecen automáticamente.

4 Confirme los canales registrados.



● Para poner en la memoria los canales que fueron localizados mediante la exploración automática, mueva el cursor a “Aceptar” y pulse OK.

■ Pulse para salir ó volver a la pantalla anterior.



Nota

● Para cambiar la configuración posteriormente, vaya a la pantalla Menu (págs. 30-31)

Para ver la televisión

Conecte el receptor de televisión por cable cuando vaya a ver televisión por cable. (pág. 25)
 Conecte directamente el televisor por cable a la terminal "ANT" para recibir emisiones digitales de televisión por cable.

1 Cambie al modo de televisión.



3 Seleccione un número de canal.

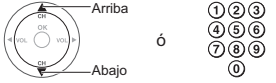

Arriba
Abajo

2 Conecte la alimentación



■ **Otras funciones útiles** (Utilícelas después de 3)

Temporizador para acostarse

Apaga la unidad después de pasar un periodo de tiempo de 0 a 90 minutos que puede ajustarse a intervalos de 30 minutos.
 SLEEP REW 0/30/60/90 (minutos)

Demostraciones de imágenes

FF DEMO Si Modo vivo Demostración No
 Demuestra la calidad de la imagen en el modo vivo. (págs. 30-31)

Escucha con SAP (Programa de audio secundario)

■ **Seleccione el modo de audio para ver la televisión.**

SAP

- **Modo digital**
 Pulse SAP para seleccionar la siguiente pista de audio (si está disponible) cuando se recibe un canal digital.
 Pista de audio 1 de 1 (Inglés)
- **Modo analógico**
 Pulse SAP para seleccionar el modo de audio como se describe a continuación.
 • Cada vez que se pulsa el botón SAP, el modo de audio cambiará como se muestra a continuación. (Estereo/SPA/Mono)

Recuperación de información

Visualice ó elimine la bandera de canales.

Canal	15-2	CC	SPA	TV-G	1080i	Estándar	4:3	30
Identificador de emisora	ABC - HD							
Nivel de clasificación								
Relación de aspecto								

Cambio de la relación de aspecto

TV/VCR ASPECT

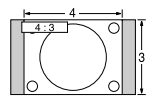

- El modo cambia con cada pulsación.
- 480i, 480p:COMP/JUSTO/4:3/ACERC
- 1080i, 720p:COMP/H-LLENO/JUSTO/4:3

Llamada a un canal favorito

FAVORITE GUIDE

FAVORITOS

Los números de canales de Favoritos se visualizan en la pantalla de sintonización de favoritos. Seleccione la emisora deseada con el cursor ó usando las teclas de números. (vea debajo)

Nota

- Vuelva a seleccionar "Cable" ó "Antena" en "ANT In" de "Programa auto" para cambiar la recepción de la señal entre televisión por cable y antena.
- El número del canal y el nivel del volumen se fijan incluso después de apagar el televisor.

Configuración de la función de favoritos

- Visualice el canal que va a colocar en la lista de favoritos.
- FAVORITE GUIDE
 Mantenga pulsado FAVORITE durante varios segundos.
 • Pulse repetidamente FAVORITE para cambiar entre las páginas (1/3, 2/3, 3/3 ó salir). Al pulsar ◀ ▶ también cambia la página.

Ajustes 1/3
 [1]
 [2]
 [3]
 [4]

- Seleccione Aceptar
 Pulse ▲ ▼ para resaltar una posición en la lista. Y luego pulse OK para memorizar el canal visualizado en esa posición.
 • También puede utilizar las teclas numéricas (1-9 y 0) para seleccionar los números de lista grabados (1-9 y 0). Al hacer esto, los números se grabarán directamente sin tener que pulsar la tecla OK.

Ajustes 1/3
 [1] 26-1
 [2]
 [3]
 [4]

- **Para eliminar un canal favorito**
 Un canal memorizado se podrá eliminar de la lista manteniendo pulsado FAVORITE mientras su posición está resaltada.

Utilización de la función de favoritos

- FAVORITE GUIDE
 Pulse FAVORITE.
 • Pulse repetidamente FAVORITE para cambiar entre las páginas (1/3, 2/3, 3/3 ó salir). Al pulsar ◀ ▶ también cambia la página.

Favoritos 1/3
 [1]
 [2]
 [3]
 [4]

- Seleccione
 Pulse ▲ ▼ ó una tecla numerada (1-9 y 0) para resaltar un canal de la lista.
 • Al seleccionar un número de canal de la lista con las teclas numeradas se visualizará directamente el canal.
- Aceptar
 Pulse OK para visualizar el canal resaltado.

Cómo utilizar las funciones de los menús

Varios menús le permiten seleccionar configuraciones para la imagen, el sonido y otras funciones, para poder disfrutar viendo la televisión con sus preferencias establecidas.

1 Visualice el menú
 ● Visualiza las funciones que pueden establecerse (cambia según la señal de entrada).

2 Seleccione el menú
 ● Seleccione el menú deseado.

3 Seleccione el elemento
 ● Seleccione el elemento deseado.

4 Ajuste ó selección
 ● Ajuste ó Selección.

■ Pulse para salir ó volver a la pantalla anterior.
 RETURN
 EXIT

■ Lista de menús

Menú	Elemento	
Imagen	Normal	
	Modo	
	Luz de atrás	
	Contraste, Brillo, Color, Tinte, Nitidez	
	Temp color	
	Modo vivo	
	Imagen IA	
	Ajuste acerc.	
	Reduc de ruido	
	3D Y/C filtro	
Otros ajustes	Matriz color	
	Nivel oscuro	
	Normal	
	Bajos	
	Altos	
Audio	Balance	
	Sonido IA	
	Envolvente	
	Ent. HDMI1, Ent. HDMI2	
Otros ajustes	Norm. de audio	
	Apagado	
Cronómetro		
Bloqueo		
Ajuste	Búsqueda	
	Idioma	
	Programa canal	
	Títulos de entradas	
	CC	
	Otros ajustes	Autoencendido
		Para prog-out
		Ctrl con HDMI
		Econ. energía
	Acerca de	
Restaurar		

Ajustes / Configuraciones (alternativas)													
Restablece la configuración del menú de imagen (excepto para "Otros ajustes").	Normal <input type="checkbox"/> SI												
Modo de imagen básico (Vivid/Estándar/Cinema)	Modo <input type="checkbox"/> Estándar												
Ajusta la luminancia de la luz de fondo.	Luz de atrás <input type="checkbox"/> +20												
Ajusta el color, el brillo, etc. para que cada modo de imagen se ajuste a sus gustos.	<table border="1"> <tr> <td>Contraste</td> <td>+20</td> <td>Tinte</td> <td>0</td> </tr> <tr> <td>Brillo</td> <td>0</td> <td>Nitidez</td> <td>0</td> </tr> <tr> <td>Color</td> <td>0</td> <td></td> <td></td> </tr> </table>	Contraste	+20	Tinte	0	Brillo	0	Nitidez	0	Color	0		
Contraste	+20	Tinte	0										
Brillo	0	Nitidez	0										
Color	0												
Selecciona el nivel de los colores cálidos (rojo) y de los colores fríos (azul). (Rojo/Azul/Normal)	Temp color <input type="checkbox"/> Azul												
Realza la reproducción de los colores verde y azul, especialmente en las escenas de exteriores. (Si/No)	Modo vivid <input type="checkbox"/> No												
Controla las áreas oscuras sin afectar al nivel del negro ni al brillo de la imagen en general. (Si/No)	Imagen IA <input type="checkbox"/> SI												
Ajusta la alineación vertical y el tamaño cuando el ajuste del aspecto es "ACERC"	Ajuste acerc. <input type="checkbox"/>												
Reduce el ruido en el canal, comúnmente llamado efecto de nieve. Permanece en No cuando se recibe una señal intensa. (Si/No)	Reduc de ruido <input type="checkbox"/> No												
Minimiza el ruido y la diafotia cromática en la imagen. (Si/No)	3D Y/C filtro <input type="checkbox"/> No												
Selecciona la resolución de la imagen de los dispositivos conectados a componentes. (SD/HD)	Matriz color <input type="checkbox"/> SD												
● SD: Visión normal HD: Visión de alta definición													
● Sólo se acepta la señal 480 p, la televisión convencional (NTSC) no se está disponible.													
Selecciona Oscuro ó Claro dependiendo de las condiciones de la imagen. (Oscuro/Claro)	Nivel oscuro <input type="checkbox"/> Claro												
Las escenas oscuras se pueden ver fácilmente. (Sólo es válido para señales de entrada externas.)													
Repone los ajustes de Bajos, Altos y Balance los ajustes predeterminados en la fábrica.	Normal <input type="checkbox"/> SI												
Aumenta ó disminuye la respuesta de los graves.	Bajos <input type="checkbox"/> +4												
Aumenta ó disminuye la respuesta de los agudos.	Altos <input type="checkbox"/> 0												
Repone los ajustes de Bajos, Altos y Balance los ajustes predeterminados en la fábrica.	Balance <input type="checkbox"/> 0												
Iguale los niveles del sonido en todos los canales y entradas VIDEO. (Si/No)	Sonido IA <input type="checkbox"/> SI												
Mejora la respuesta de audio cuando se escucha sonido estéreo. (Si/No)	Envolvente <input type="checkbox"/> No												
Selecciona según la señal cuando está conectado HDMI. (Auto/Digital/Análogo)	Ent. HDMI1 <input type="checkbox"/> Auto												
● Auto: Selecciona automáticamente la señal analógica/digital.													
Minimiza la diferencia de volúmen después de cambiar a entradas externas.	Norm. de audio <input type="checkbox"/> 0												
Apaga automáticamente el televisor después de transcurrido el periodo de tiempo preestablecido. ● 0/30/60/90 (minutos)	Apagado <input type="checkbox"/> 60												
También es posible hacer el ajuste del temporizador pulsando el botón "Sleep" del mando a distancia. (pág. 28)													
Bloquea canales y programas.													
Selecciona los canales que van a visualizarse cuando se pulsan los botones "canal arriba/abajo". (Fav./Todos)	Búsqueda <input type="checkbox"/> Todos												
● Fav.: Sólo cuando se registran canales como Favoritos													
Selecciona el idioma para los menús de la pantalla. (pág. 27)	Idioma <input type="checkbox"/>												
Establece los canales de recepción.	Programa canal <input type="checkbox"/>												
Etiquetas de visualización de dispositivos externos	Títulos de entradas <input type="checkbox"/>												
Visualiza subtítulos (subtítulos)	CC <input type="checkbox"/>												
Establece cómo se va a conectar la alimentación del televisor. (Si/No)	Autoencendido <input type="checkbox"/> No												
SI : Conecte la clavija del cable de alimentación al receptor de televisión por cable, etc., y controle el encendido/apagado del televisor en el equipo conectado. (El temporizador para acostarse no funcionará si está activado "Autoencendido".)													
No : Suministre alimentación desde una toma de corriente y controle el encendido/apagado del televisor en el propio televisor. (El menú "Ajuste inicial" se visualiza cuando la clavija del cable de alimentación vuelve a conectarse después de desconectarla de la toma de corriente.)													
Para impedir el aullido y la oscilación de la imagen, detenga la salida de la imagen y el sonido especificados en este menú (pág. 35). (No/Comp./HDMI 1/HDMI 2/Video 1/Video 2/Video 3)	Para prog-out <input type="checkbox"/> No												
● Comp./HDMI 1/HDMI 2 no puede dar salida a señales de vídeo independientemente del ajuste de "Para prog-out".													
Controla los equipos conectados a los terminales HDMI (pág. 33, 34) (Si/No)	Ctrl con HDMI <input type="checkbox"/> SI												
Reduce el brillo de la pantalla para disminuir el consumo de energía. Para ver programas en habitaciones oscuras sin que se canse la vista. (Estándar/Ahorro)	Econ. energía <input type="checkbox"/> Estándar												
Visualiza la versión del televisor y la licencia del software.	Acerca de <input type="checkbox"/>												
Al realizar la reposición se cancelarán todos los elementos establecidos con Ajuste como, por ejemplo, los ajustes de canales. Utilice la reposición con cuidado.	Restaurar <input type="checkbox"/>												

● En el modo Video, el menú Audio y el menú Ajuste ofrecen un número inferior de opciones.

Para ver vídeos y DVDs

Algunos dispositivos de Panasonic conectados al televisor pueden ser controlados con el mando a distancia.

Para controlar los productos de otros fabricantes se necesita programar el mando a distancia.

1 Con la videogradora ó DVD encendido
Cambie a entrada externa.
Pulse para visualizar el menú de selección de entrada.
TV/VIDEO

2 **Seleccione el modo de entrada.**

Seleccionar entrada	1 2 3
[1] TV	4 5 6
[2] Componente	7 8 9
[3] HDMI 1	0
[4] HDMI 2	0
[5] Video 1	0
[6] Video 2	0
[7] Video 3	0

 Seleccione. Pulse para seleccionar la entrada de su elección y luego pulse "OK".
 Introducir. Si, durante la selección, no se realiza ninguna acción durante varios segundos, se saldrá del menú de selección de entrada.

3 **Utilice** la videogradora ó DVD con el mando a distancia (ejemplo)

El terminal y la etiqueta del dispositivo conectado se indican. Para etiquetar cada uno de los dispositivos conectados (pág. 13)

Etiqueta Terminal
[ejemplo]

■ Para volver al televisor TV/VIDEO

Nota
● Para conocer detalles, vea el manual del equipo ó pregunte a su concesionario local.

	Videogradora	DVD
SLEEP REW FF DEMO	Retroceso/Avance rápido	Retroceso/Avance
PLAY	Reproducción	Reproducción
PAUSE	Pausa	Pausa
STOP	Parada	Parada
REC	Grabación de videogradora	—
TV/VCR ASPECT	Televisor/Videogradora	Abertura/Cierre
VCR/DBS CH	Canal abajo/arriba	Retroceso/avance lento

Control con HDMI "HDAVI Control™"

Los productos de audio-video de Panasonic más recientes equipados con conexiones de salida HDMI pueden ser controlados utilizando el mando a distancia del televisor. Se encuentran disponibles funciones limitadas como, por ejemplo, el cambio automático a la entrada HDMI del televisor.

- Esta función se limita a los modelos que incorporan "Control con HDMI" de Panasonic.
- Consulte los manuales de instrucciones individuales para obtener información relacionada con la compatibilidad.
- No se pueden utilizar cables que no cumplan con HDMI.
- Se recomienda utilizar un cable HDMI de Panasonic.
Número de pieza recomendada: RP-CDHG15 (1,5 m)
RP-CDHG30 (3,0 m)
RP-CDHG50 (5,0 m)

Cambio de entrada automático	Cuando "Ctrl con HDMI" se ponga en "Si", al empezar la reproducción del equipo compatible con el control HDAVI, la entrada del televisor cambiará automáticamente a la entrada correspondiente al equipo de reproducción. ● Si se utiliza la operación DIGA, la entrada del televisor cambia automáticamente a DIGA y se visualiza el menú DIGA. Si la alimentación del TV está desconectada, ésta se conecta automáticamente.
Prende control	Cuando "Ctrl con HDMI" se ponga en "Si", el televisor se encenderá automáticamente y cambiará a la entrada HDMI apropiada siempre que el equipo compatible con el control HDAVI se encuentre inicialmente encendido y el modo de reproducción esté seleccionado.
Apaga control	Cuando "Ctrl con HDMI" se ponga en "Si" y se apague el televisor, el equipo compatible con el control HDAVI conectado también se apagará automáticamente. ● DIGA (grabadora DVD de Panasonic) no se apagará si aún está en el modo de grabación.

- Precaución**
● El televisor permanecerá encendido aunque se apague el equipo compatible con "Control con HDMI".
- Nota**
● Antes de utilizar las funciones de control HDMI, el equipo conectado deberá configurarse. Para conocer detalles, vea el manual de funcionamiento de cada equipo.
● Para conocer detalles de la conexión del equipo, vea la pág. 34.
● El ajuste predeterminado es "Si". Si no están conectados equipos HDMI ó se utilizan equipos HDMI estándar (que no sean "Control con HDMI"), ajuste en "No". (vea debajo)

1 Visualice el menú.
MENU

2 Seleccione "Ajuste".
Menú
Imagen
Audio
Cronómetro
Bloqueo
Ajuste

3 Seleccione "Otros ajustes".
Ajuste
Búsqueda Todos
Idioma
Programa canal
Títulos de entradas
CC
Otros ajustes

4 Seleccione "Ctrl con HDMI".
Otros ajustes
Autoencendido No
Para prog-out No
Ctrl con HDMI Si
Econ. energía Estándar

5 Seleccione "Si" ó "No".
RETURN
EXIT

● Control con HDMI "HDAVI Control™"
● Para ver vídeos y DVDs

Español
[Resumen]

Conexiones AV recomendadas

Estos diagramas muestran nuestras recomendaciones sobre cómo conectar el televisor a varios equipos. Para hacer otras conexiones, consulte las instrucciones de cada equipo y las especificaciones (pág. 45). Para obtener ayuda adicional, visite nuestro sitio Web www.panasonic.com.

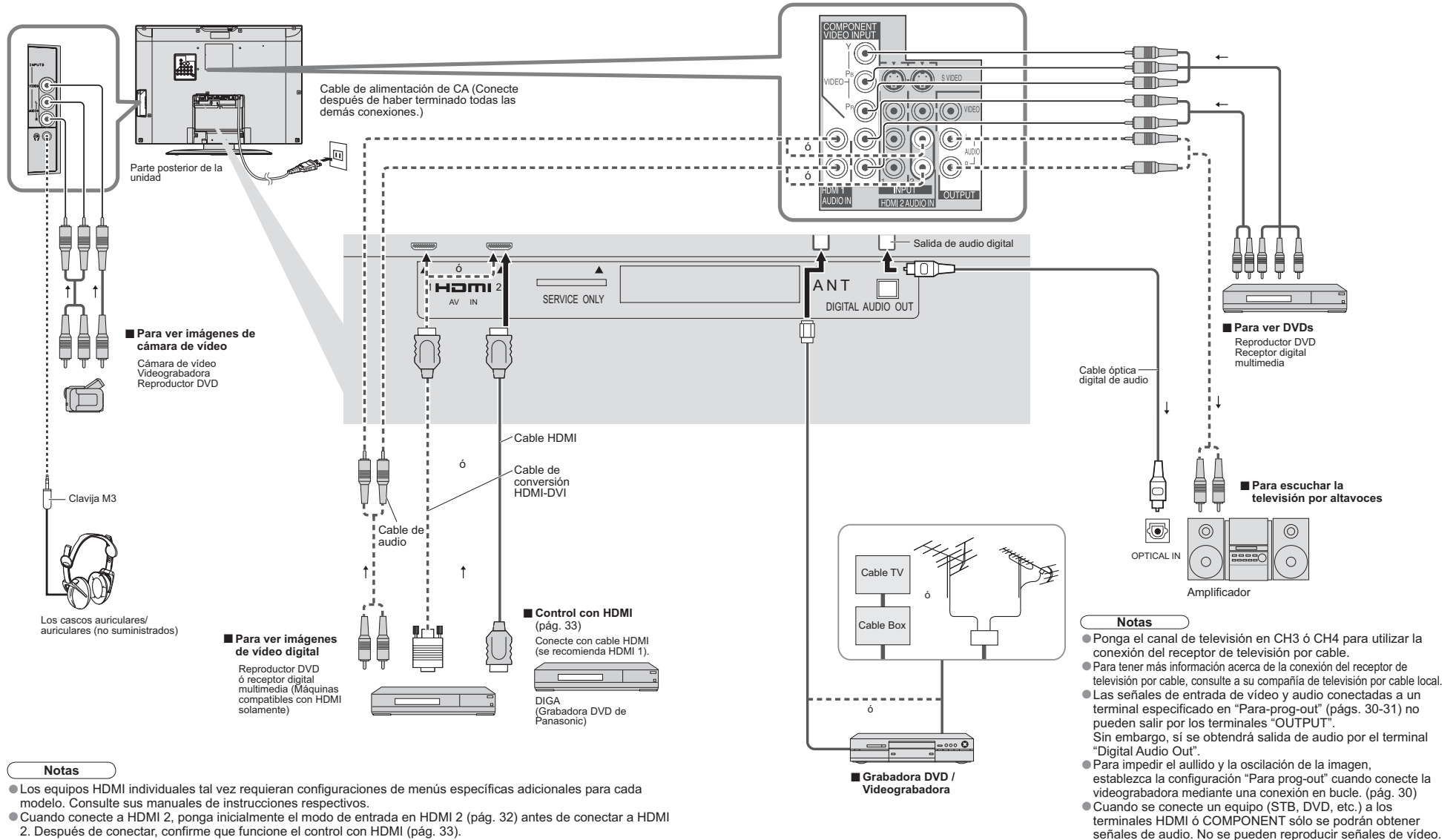

Remote Control Operation/Code List

The following explains how to operate external equipment with the remote control.

- Register the remote control codes (p. 20) if you want to operate an external equipment of another manufacturer. (p. 37-38)

Note

- Operation may not be possible depending on the available memory size of the remote control. This remote control is not designed to cover operation of all functions of all models.

Remote Control Operation List

This chart defines which keys are operational after programming (if needed), while in the selected remote control mode, DTV, CABLE, DBS, VCR, DVD.

KEY NAME	VCR MODE	DBS/CBL MODE		DVD MODE
		(DBS)	(CBL)	
	Power	Power	Power	Power
	—	CH Up, Cursor Up	CH Up, Cursor Up	Skip Up
	—	CH Down, Cursor Down	CH Down, Cursor Down	Skip Down
	Vol Down	DBS Cursor Left	CBL Cursor Left	Vol Down
	Vol Up	DBS Cursor Right	CBL Cursor Right	Vol Up
	—	DBS Menu	CBL Menu	—
	—	Exit	Exit	—
	TV Input Switch	TV Input Switch	TV Input Switch	TV Input Switch
	Onscreen Display	Onscreen Display	Recall	Onscreen Display
	TV Mute	TV Mute	TV Mute	TV Mute
	—	Guide	Guide	—
	—	0-9	0-9	—
	Rewind	—	—	Reverse
	Play	—	—	Play
	Fast Forward	—	—	Forward
	Pause	—	—	Pause
	Stop	—	—	Stop
	VCR Record	—	PVR Record ^{*1}	—
	TV/VCR	Aspect	Aspect	Open/Close
	Channel Down	Page Down	Page Down	Slow Reverse
	Channel Up	Page Up	Page Up	Slow Forward

*1: Combination type

Remote Control Code List

Cable Converter (DBS/CBL)

Brand	Code	Brand	Code	Brand	Code	Brand	Code
ABC	0003, 0008	Hamlin	0009, 0273	Philips	0317, 1305	Scientific Atlanta	0008, 0477, 0877, 1877
Americast	0899	Jerrold	0003, 0276, 0476, 0810	Pioneer	0144, 0533, 0877, 1877	Sony	1006
Bell South	0899	Memorex	0000	Pulsar	0000	Starcom	0003
Digeo	1187	Motorola	1376, 0276, 0476, 0810, 1187	Quasar	0000	Supercable	0276
Director	0476	Pace	0008, 0237, 1877	Regal	0273, 0279	Torx	0003
General Instrument	0003, 0276, 0476, 0810	Panasonic	0000, 0107	Runco	0000	Toshiba	0000
GoldStar	0144	Paragon	0000	Samsung	0144	Zenith	0000, 0525, 0899

Satellite Receiver (DBS/CBL)

AlphaStar	0772	General Instrument	0869	Magnavox	0722, 0724	Samsung	1108, 1109, 1142, 1276, 1377, 1442, 1609
Chaparral	0216	GOI	0775, 1775	Memorex	0724	Sanyo	1219
Crossdigital	1109	Goodmans	1246	Mitsubishi	0749	Sony	0639, 1639, 1640
DirecTV	0099, 0247, 0392, 0566, 0639, 0724, 0749, 0819, 1076, 1108, 1109, 1142, 1377, 1392, 1414, 1442, 1443, 1444, 1609, 1639, 1640, 1749, 1856	Hisense	1535	NEC	1270	Star Choice	0869
		Hitachi	0819, 1250	Next Level	0869	Tivo	1142, 1442, 1443, 1444
		HTS	0775, 1775	Panasonic	0152, 0247, 0701, 1786	Toshiba	0749, 0790, 0819, 1285, 1749
		Hughes	0749, 1442, 1749	Paysat	0724	UltimateTV	1392, 1640
Dish Network System	0775, 1005, 1170, 1505, 1775	Hughes Network Systems	0749, 1142, 1442, 1443, 1444, 1749	Philips	0099, 0722, 0724, 0749, 0819, 1076, 1142, 1442, 1749	Uniden	0722, 0724
Dishpro	0775, 1005, 1505, 1775	iLo	1535	Pioneer	1442	USDTV	1535
Echostar	0775, 1005, 1170, 1505, 1775	Janeil	0152	Proscan	0392, 0566	Voom	0869
Expressvu	0775, 1775	Jerrold	0869	Proton	1535	Zenith	1856
GE	0392, 0566	JVC	0775, 1170, 1775	RadioShack	0869		
		LG	1226, 1414	RCA	0143, 0392, 0566, 0855, 1392		

Cable/PVR Combination (DBS/CBL)

Americast	0899	Jerrold	0476, 0810	Pioneer	0877, 1877	Supercable	0276
Digeo	1187	Motorola	0476, 0810, 1187, 1376	Scientific Atlanta	0877, 1877	Zenith	0899
General Instrument	0476, 0810	Pace	0237, 1877	Sony	1006		

DBS/PVR Combination (DBS/CBL)

DirecTV	0099, 0392, 0639, 1076, 1142, 1377, 1392, 1442, 1443, 1444, 1640	Dishpro	0775, 1505	JVC	1170	Samsung	1442
		Echostar	0775, 1170, 1505	Motorola	0869	Sony	0639, 1640
Dish Network System	0775, 1505	Expressvu	0775	Philips	1142, 1442	Star Choice	0869
		Hughes Network Systems	1142, 1442, 1443, 1444	Proscan	0392		
				RCA	1392		

VCR (VCR)

ABS	1972	Hewlett Packard	1972	NEC	0067	Scott	0043, 0045
Adventura	0000	Hitachi	0000, 0042, 0089	Nikko	0037	Sears	0000, 0035, 0037, 0042, 1237
Aiwa	0000, 0037, 0124	Howard Computers	1972	Niveus Media	1972	Sharp	0807, 0848
Akai	0175	HP	1972	Northgate	1972	Sonic Blue	0614, 0616
Alienware	1972	Hughes Network Systems	0042, 0739	Olympus	0035, 0226	Sony	0000, 0032, 0033, 0035, 0636, 1032, 1232, 1972
American High	0035	Humax	0739	Onkyo	0222	Stack 9	1972
Audiovox	0037	Hush	1972	Optimus	0037	STS	0042
Broksonic	1479	iBUYPOWER	1972	Orion	1479	Sylvania	0000, 0035, 0043, 1781
Calix	0037	JVC	0067	Panasonic	0035, 0077, 0225, 0226, 0227, 0378, 0616, 1035, 1244	Symphonic	0000
Canon	0035	KEC	0037	Penney	0035, 0037, 0042, 1035, 1237	Systemax	1972
Citizen	0037, 1278	Kenwood	0067	Pentax	0042	Tagar Systems	1972
Craig	0037	Kodak	0035, 0037	Philco	0035	Teac	0000
Curtis Mathes	0035, 0060, 1035	Linksys	1972	Philips	0035, 0618, 0739, 1081, 1181	Technics	0035
CyberPower	1972	Lloyd's	0000	Pilot	0037	Teknika	0000, 0035, 0037
Daewoo	0045, 1278	LXI	0037	Pioneer	0067	Thomas	0000
Dell	1972	Magnasonic	1278	Proscan	0060, 1060	Tivo	0618, 0636, 0739
Denon	0042	Magnavox	0000, 0035, 0039, 1781	Pulsar	0039	Toshiba	0043, 0045, 0845, 1008, 1145, 1972
DirecTV	0739	Marantz	0035	Quasar	0035, 0077, 1035	Totevision	0037
Durabrand	0039	Marta	0037	RadioShack	0000	Touch	1972
Dynatech	0000	Matsushita	0035	Radix	0037	Vector	0045
Electrohome	0037, 0043	Media Center PC	1972	Randex	0037	Video Concepts	0045
Electrohome	0037	MEI	0035	RCA	0042, 0060, 0077, 0807, 0880, 1035, 1060	Videomagic	0037
Emerex	0032	Memorex	0000, 0035, 0037, 0039, 1237	Realistic	0000, 0035, 0037	Viewsonic	1972
Emerson	0000, 0037, 0043, 1278, 1479	MGA	0043	ReplayTV	0614, 0616	Villain	0000
Fuji	0033, 0035	Microsoft	1972	Ricavision	1972	Voodoo	1972
Funai	0000	Mind	1972	Runco	0039	Wards	0000, 0035, 0042, 0060
Garrard	0000	Minolta	0042	Samsung	0045, 0739, 1014	XR-1000	0000, 0035
Gateway	1972	Mitsubishi	0043, 0067, 0807	Sanky	0039	Zenith	0000, 0033, 0039, 1479
GE	0035, 0060, 0807, 1035, 1060	Motorola	0035	Sansui	0000, 0067, 1479	ZT Group	1972
GoldStar	0037, 1237	MTC	0000	Sanyo	0159		
Gradiente	0000	Multitech	0000				
Harley Davidson	0000						

Remote Control Operation/Code List

Remote Control Code List

DBS/PVR Combination (VCR)							
Brand	Code	Brand	Code	Brand	Code	Brand	Code
Hughes Network Systems	0739	Philips	0739				
		Samsung	0739				
PVR(VCR)							
ABS	1972	Hughes Network Systems	0739	Niveus Media	1972	Systemax	1972
Alienware	1972			Northgate	1972	Tagar Systems	1972
CyberPower	1972	Humax	0739	Panasonic	0616		
Dell	1972	Hush	1972	Philips	0618, 0739	Tivo	0618, 0636, 0739
DirecTV	0739	iBUYPOWER	1972	RCA	0880	Toshiba	1008, 1972
Gateway	1972	Linksys	1972	ReplayTV	0614, 0616	Touch	1972
Hewlett Packard	1972	Media Center PC	1972	Sonic Blue	0614, 0616	Viewsonic	1972
Howard Computers	1972	Microsoft	1972	Sony	0636, 1972	Voodoo	1972
HP	1972	Mind	1972	Stack 9	1972	ZT Group	1972
DVD (DVD)							
Adcom	1094	GoldStar	0741	Onkyo	0503, 0792	Sensory Science	1158
Allegro	0869	Gradiente	0490			Sharp	0630, 0675, 0752, 1256
Apex Digital	0672, 0794, 0796, 0797, 1004, 1056, 1061, 1100	Grundig	0539	Panasonic	0490, 0503, 0632, 0703, 1010, 1011, 1362, 1462, 1490, 1762, 1967	Shin Sonic	0533
Aspire Digital	1168	Hitachi	0573, 0664			Sonic Blue	0869
Blue Parade	0571	Hiteker	0672	Philips	0503, 0539, 0646, 0675, 1267, 1354	Sony	0533, 0864, 1033, 1431, 1533
Broksnic	0695	Integra	0571			Sylvania	0675
California Audio Labs	0490	JVC	0558, 0623, 0867, 1164, 1275	PianoDisc	1024	Symphonic	0675
CineVision	0833, 0869	Kenwood	0490, 0534	Pioneer	0525, 0571, 0631, 0632	Teac	0809
Coby	1086	Lecon	1533	Polaroid	1061, 1086	Technics	0490, 0703
CyberHome	0816, 1023, 1024, 1129	LG	0591, 0741, 0801, 0869	Polk Audio	0539	Theta Digital	0571
Daewoo	0833, 0869	LiteOn	1158, 1440	Procead	0672	Toshiba	0503, 0695, 1045, 1154
Denon	0490	Loewe	0511	Proscan	0522	Urban Concepts	0503
Disney	0675	Magnavox	0503, 0539, 0646, 0675	RCA	0522, 0571, 0822	Xbox	0522
DVD2000	0521	Marantz	0539	Rio	0869	Yamaha	0490, 0539, 0545
Emerson	0591, 0675	McIntosh	1533	Rotel	0623	Zenith	0503, 0591, 0741, 0869
Enterprise	0591	Memorex	0695	Sampo	0752		
Funai	0675	Microsoft	0522	Samsung	0490, 0573, 0820, 1075		
Gateway	1158	Microsoft	0522	Sansui	0695		
GE	0522	Mitsubishi	0521, 1521	Sanyo	0695, 0873, 1967		
Go Video	0741, 0833, 0869, 1075, 1158, 1304, 1730	NAD	0591, 0741				
		NEC	0785				
DVD Recorder (DVD)							
Apex Digital	1056	Go Video	0741, 1158, 1304, 1730	Philips	0646	Sensory Science	1158
Aspire Digital	1168	JVC	1164, 1275	Pioneer	0631	Sharp	0675
Coby	1086	LG	0741	Polaroid	1086	Sony	1033, 1431
CyberHome	1129	LiteOn	1158, 1440	RCA	0522	Sylvania	0675
Funai	0675	Magnavox	0646	Samsung	0490	Zenith	0741
Gateway	1158	Panasonic	0490, 1010, 1011				

Ratings List for Channel Lock

"V-chip" technology enables you to lock out channels or shows according to standard ratings set by the entertainment industry. (p. 17)

U.S. MOVIE RATINGS (MPAA)

Off	NO RATING (NOT RATED) AND NA (NOT APPLICABLE) PROGRAMS. Movie has not been rated or rating does not apply.
G	GENERAL AUDIENCES. All ages admitted.
PG	PARENTAL GUIDANCE SUGGESTED. Some material may not be suitable for children.
PG-13	PARENTS STRONGLY CAUTIONED. Some material may be inappropriate for children under 13.
R	RESTRICTED. Under 17 requires accompanying parent or adult guardian.
NC-17	NO ONE 17 AND UNDER ADMITTED.
X	ADULTS ONLY.

U.S. TV PROGRAMS RATINGS (U. S. T. V)

Age-based Group	Age-based Ratings	Possible Content Selections	Description
NR (Not Rated)	TV-NR	<ul style="list-style-type: none"> Viewable Blocked 	Not Rated.
Youth	TV-Y	<ul style="list-style-type: none"> Viewable Blocked 	All children. The themes and elements in this program are specifically designed for a very young audience, including children from ages 2-6.
	TV-Y7	<ul style="list-style-type: none"> FV Blocked Viewable Blocked 	Directed to older children. Themes and elements in this program may include mild physical or comedic violence, or may frighten children under the age of 7.
	TV-G	<ul style="list-style-type: none"> Viewable Blocked 	General audience. It contains little or no violence, no strong language, and little or no sexual dialogue or situations.
Guidance	TV-PG	<ul style="list-style-type: none"> D,L,S,V (all selected) Any combination of D, L, S, V 	Parental guidance suggested. The program may contain infrequent coarse language, limited violence, some suggestive sexual dialogue and situations.
	TV-14	<ul style="list-style-type: none"> D,L,S,V (all selected) Any combination of D, L, S, V 	Parents strongly cautioned. This program may contain sophisticated themes, sexual content, strong language and more intense violence.
	TV-MA	<ul style="list-style-type: none"> D,L,S,V (all selected) Any combination of L, S, V 	Mature audiences only. This program may contain mature themes, profane language, graphic violence, and explicit sexual content.

FV: Fantasy/Cartoon Violence. V: Violence S: Sex L: Offensive Language D: Dialogue with sexual content.

CANADIAN ENGLISH RATINGS (C. E. L. R)

E	Exempt - Exempt programming includes: news, sports, documentaries and other information programming, talk shows, music videos, and variety programming.
C	Programming intended for children under age 8. No offensive language, nudity or sexual content.
C8+	Programming generally considered acceptable for children 8 years and over. No profanity, nudity or sexual content.
G	General programming, suitable for all audiences.
PG	Parental Guidance suggested. Some material may not be suitable for children.
14+	Programming contains themes or content which may not be suitable for viewers under the age of 14. Parents are strongly cautioned to exercise discretion in permitting viewing by pre-teens and early teens.
18+	18+ years old. Programming restricted to adults. Contains constant violence or scenes of extreme violence.

CANADIAN FRENCH RATINGS (C. F. L. R)

E	Exempt - Exempt programming.
G	General - Programming intended for audience of all ages. Contains no violence, or the violence content is minimal or is depicted appropriately.
8 ans+	8+ General - Not recommended for young children. Programming intended for a broad audience but contains light or occasional violence. Adult supervision recommended.
13 ans+	Programming may not be suitable for children under the age of 13 - Contains either a few violent scenes or one or more sufficiently violent scenes to affect them. Adult supervision strongly suggested.
16 ans+	Programming may not be suitable for children under the age of 16 - Contains frequent scenes of violence or intense violence.
18 ans+	Programming restricted to adults. Contains constant violence or scenes of extreme violence.

Technical Information

Closed Caption (CC)

- For viewing Closed Caption of digital broadcasting, set the aspect ratio to FULL. (If viewing with H-FILL, JUST, ZOOM or 4:3, characters will be cut off.)
- The closed caption is not displayed when you use HDMI connection.
- If analog connected equipment is used for displaying or recording, closed caption (CC) should be set On/Off on the connected equipment.
The CC mode setting of the TV will not affect the analog input.
If a digital program is being output in analog format, the CC data will also be output in analog format.
If digital connected equipment is used for input, CC should be set On on either the connected equipment or the TV.
If CC is set On on both the connected equipment and the TV, captions from each unit will overlap.

Aspect Ratio

Let you choose the aspect depending on the format of the received signal and your preference. (p. 11) (e.g.: in case of 4:3 image)

● FULL

Enlarges the 4:3 image horizontally to the screen's side edges. (Recommended for anamorphic picture)

● JUST

Stretches to justify the 4:3 image to the four corners of the screen. (Recommended for normal TV broadcast)

● H-FILL

Enlarges the 4:3 image horizontally to the screen's side edges. The side edges of the image are cut off.

● 4:3

Standard (Note that "after image" of the side bar may occur from displaying it for a long time.)

● ZOOM

Enlarges the 4:3 image to the entire screen. (Recommended for Letter Box)

Note

- 480i (4:3), 480i (16:9), 480p (4:3), 480p (16:9) : FULL, JUST, 4:3 or ZOOM
- 1080i / 720p : FULL, H-FILL, JUST or 4:3
- When the signal is 720p/1080i, the aspect mode automatically defaults to Full after turning off the TV, after changing input mode, or after changed signal resolution other than 720p/1080i.

- Zoom adjust
Vertical image position and size can be adjusted in "ZOOM."
① Select "Zoom adjust" on the "Picture" menu. (p. 14-15)
② V-Position: Vertical position adjustment

- ③ Size: Vertical size adjustment



- To reset the aspect ratio → (OK)

DIGITAL AUDIO OUT terminals

You can enjoy your home theater by connecting a Dolby Digital (5.1 channel) decoder and "Multi Channel" amplifier to the DIGITAL AUDIO OUT terminals.

Caution

- Depending on your DVD player and DVD-Audio software the copyright protection function may operate and disable optical output.
- External speakers cannot be connected directly to OUTPUT terminals.
- When ATSC channel is selected, the output from the DIGITAL AUDIO OUT jack will be Dolby Digital. When NTSC channel is selected, the output will be PCM.

Control with HDMI "HDMI Control™"

HDMI connections to some Panasonic equipment allow you to enjoy easy playback.

- Setup the equipment to enable this function. Read the manual of the equipment.
- Switch the TV unit on again with the equipment on when connection or setup is changed.
- This function may not work normally depending on the equipment condition.
- The equipment can be operated by TV's remote control with this function on even if TV is in Standby mode.
- Image or sound may not be available for the first few seconds when the playback starts.
- Image or sound may not be available for the first few seconds when Input mode is switched.

HDMI connection

HDMI (high-definition multimedia interface) allows you to enjoy high-definition digital images and high-quality sound by connecting the TV unit and the equipment.

HDMI-compatible equipment (*1) with an HDMI or DVI output terminal, such as a set-top box or a DVD player, can be connected to the HDMI connector using an HDMI compliant (fully wired) cable.

- HDMI is the world's first complete digital consumer AV interface complying with a non-compression standard.
- If the external equipment has only a DVI output, connect to the HDMI terminal via a DVI to HDMI adapter cable (*2).
- When the DVI to HDMI adapter cable is used, connect the audio cable to the audio input terminal.
- Audio settings can be made on the "HDMI1 in" or "HDMI2 in" menu screen. (p. 14-15)
Applicable audio signal sampling frequencies (L.PCM): 48 kHz, 44.1 kHz, 32 kHz

(*1): The HDMI logo is displayed on an HDMI-compliant equipment.
(*2): Enquire at your local digital equipment retailer shop.

Caution

- Use with a PC is not assumed.
- All signals are reformatted before being displayed on the screen.
- If the connected equipment has an aspect adjustment function, set the aspect ratio to "16:9".
- This HDMI connector is "type A".
- Equipment having no digital output terminal may be connected to the input terminal of either "COMPONENT", "S VIDEO", or "VIDEO" to receive analog signals.
- The HDMI input terminal can be used with only the following image signals: 480i, 480p, 720p and 1080i
Match the output setting of the digital equipment.
- For details of the applicable HDMI signals, see below.

Input signals that can be displayed

* Mark: Applicable input signal for Component (Y, Pb, Pr) and HDMI

	horizontal frequency (kHz)	vertical frequency (Hz)	COMPONENT	HDMI
525 (480) / 60i	15.73	59.94	*	*
525 (480) / 60p	31.47	59.94	*	*
750 (720) / 60p	45.00	59.94	*	*
1,125 (1,080) / 60i	33.75	59.94	*	*

Note

- Signals other than those shown above may not be displayed properly.
- The above signals are reformatted for optimal viewing on your display.

Pic. mode

- Vivid (default) : Provides enhanced picture contrast and sharpness for viewing in a well-lit room.
- Standard : Recommended for normal viewing conditions with subdued room lighting.
- Cinema : For watching movies in a darkened room. It provides a soft, film-like picture.

Maintenance

First, unplug the Power cord plug from the wall outlet.

Display panel

The front of the display panel has been specially treated. Wipe the panel surface gently using only a cleaning cloth or a soft, lint-free cloth.

- If the surface is particularly dirty, soak a soft, lint-free cloth in a weak detergent solution and then wring the cloth to remove excess liquid. Use this cloth to wipe the surface of the display panel, then wipe it evenly with a dry cloth, of the same type, until the surface is dry.
- Do not scratch or hit the surface of the panel with fingernails or other hard objects. Furthermore, avoid contact with volatile substances such as insect sprays, solvents and thinner; otherwise, the quality of the surface may be adversely affected.

Cabinet

If the cabinet becomes dirty, wipe it with a soft, dry cloth.

- If the cabinet is particularly dirty, soak the cloth in a weak detergent solution and then wring the cloth dry. Use this cloth to wipe the cabinet, and then wipe it dry with a dry cloth.
- Do not allow any detergent to come into direct contact with the surface of the LCD TV. If water droplets get inside the unit, operating problems may result.
- Avoid contact with volatile substances such as insect sprays, solvents and thinner; otherwise, the quality of the cabinet surface may be adversely affected or the coating may peel off. Furthermore, do not leave it for long periods in contact with articles made from rubber or PVC.

Power cord plug

Wipe the plug with a dry cloth at regular intervals. (Moisture and dust can lead to fire or electrical shock.)

FAQ

Before requesting service or assistance, please follow these simple guides to resolve the problem. If problem still persists, please contact your local Panasonic dealer or Panasonic Servicenter for assistance. For details (p. 47, 48) For additional assistance, please contact us via the website at: www.panasonic.com/contactinfo www.panasonic.ca

White spots or shadow images (noise)



- Check the position, direction, and connection of the aerial.

Interference or frozen digital channels (intermittent sound)



- Change the direction of antenna for digital channels.
- Check "Signal meter" (p. 19). If the signal is weak, check the antenna and consult your local dealer.

The LCD panel moves slightly when it is pushed with a finger Clattered sound might be heard

- There are some looseness around the panel to prevent the damage to the panel. The panel might move slightly when it is pushed with a finger, and clattered sound might be heard. This is not a malfunction.

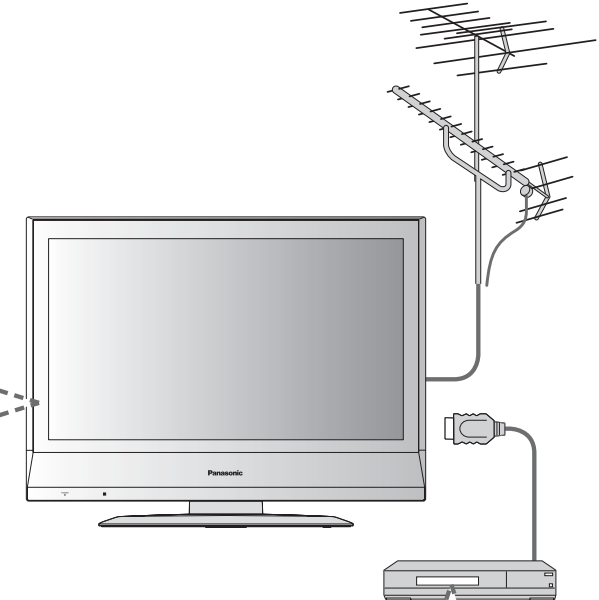

Pictures from external equipment are distorted when the unit is connected via HDMI

- Is the HDMI cable connected properly? (p. 22-23, 41)
- Turn Off the TV unit and equipment, then turn them On again.
- Check an input signal from the equipment. (p. 41)
- Use a equipment compliant with EIA/CEA-861/861B.

The remote control does not work

- Are the batteries installed correctly? (p. 6)
- Has the battery run down?
- To operate external equipment of other manufacturers, register the remote control codes. (p. 20, 37-38)

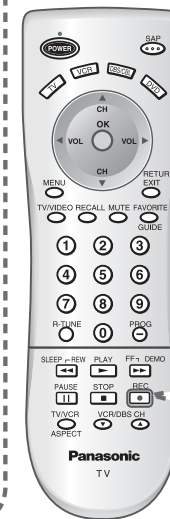

FAQ

If there is a problem with your TV please refer to the table below to determine the symptoms, then carry out the suggested check. If this does not solve the problem, please contact your local Panasonic dealer, quoting the model number and serial number (both found on the rear of the TV).

Symptoms		Checks
Picture	Sound	
Snowy Picture	Noisy Sound	● Antenna location, direction or connection.
Multiple Images	Normal Sound	● Antenna location, direction or connection.
Interference	Noisy Sound	● Electrical appliances. Cars / Motorcycles. Fluorescent lights.
Normal Picture	No Sound	● Volume level. Sound mute switched on. STEREO/SAP/MONO
No Picture	No Sound	● TV set to AV mode. Not plugged into wall outlet. Not switched on. Picture / Sound controls set at minimum levels.
No color	Normal Sound	● Color controls set at minimum levels. Weak signal.
Poor or Distorted Picture	Weak or No Sound	● Retune Channel (s).
Normal Picture	Weak, Wrong or No Sound	● Sound reception may have deteriorated. Set STEREO/SAP/MONO setting to SAP or MONO until reception improved.
Cannot operate with the remote control.		● The battery/ies is/are exhausted. The batteries' polarity is wrong. The remote control sensor is exposed to strong light from a fluorescent lamp, etc.
The main unit is hot.		● The main unit radiates heat and some of the parts may become hot. This is not a problem for performance or quality. Set up in a location with good ventilation. Do not cover the ventilation holes of the TV with a tablecloth, etc., and do not place on top of other equipment.
There may be red spots, blue spots, green spots and black spots on the screen.		● This is a characteristic of liquid crystal panels and is not a problem. The liquid crystal panel is built with very high precision technology giving you fine picture details. Occasionally, a few non-active pixels may appear on the screen as fixed points of red, blue, green, or black. Please note this does not affect the performance of your LCD.
"Control with HDMI" function does not work		● Switch the TV unit on again with the equipment on. ● Set "Control with HDMI" to "Off", then set to "On" again. (p. 21)

Specifications

	TC-26LX600	TC-32LX600
Power Source	AC 120 V, 60 Hz	
Power Consumption	Average use	113 W
	Maximum Current	2.2 A
	Standby condition	0.6 W
Sound	Aspect Ratio	16:9
	Visible screen size (W x H x Diagonal)	26.0" DIAGONAL (66.1 cm DIAGONAL)
		22.7" x 12.8" x 26.0" (576 mm x 324 mm x 661 mm)
(No. of pixels)	1,049,088 (1,366 (W) x 768(H)) [4,098 x 768 dots]	
Channel Capability-ATSC/NTSC (Digital/Analog)	Speaker	2.36" x 4.7" (60 mm x 120 mm) Full-range x 2 pcs
	Audio Output	20 W [10 W + 10 W] (10 % THD)
	Headphones	M3 (3.5mm) Jack x 1
Operating Conditions	Temperature : 32 °F -95 °F (0 °C – 35°C)	
Connection Terminals	INPUT 1-2	VIDEO : RCA PIN Type x 1 1.0 V[p-p] (75 Ω)
		S VIDEO : Mini DIN 4-pin Y:1.0 V[p-p] (75 Ω) C:0.286 V [p-p] (75 Ω)
	INPUT 3	VIDEO : RCA PIN Type x 1 1.0 V [p-p] (75 Ω)
		AUDIO L - R : RCA PIN Type x 2 0.5 V [rms]
	COMPONENT VIDEO INPUT	Y : 1.0 V [p-p] (including synchronization)
		Pb, Pr : ±0.35 V [p-p]
	HDMI 1-2 AUDIO IN	AUDIO L-R : RCA PIN Type x 2 0.5 V [rms]
TYPE A Connector x 2		
OUTPUT	VIDEO : RCA PIN Type x 1 1.0 V [p-p] (75 Ω)	
	AUDIO L - R : RCA PIN Type x 2 0.5 V [rms]	
DIGITAL AUDIO OUT	PCM / Dolby Digital, Fiber Optic	
FEATURES	3D Y/C Digital Comb Filter, CLOSED CAPTION, V-Chip HDMI Vesa compatible	
Dimensions (W x H x D)	Including TV stand	25.9" x 20.7" x 11.8" (657 mm x 525 mm x 300 mm)
	TV Set only	25.9" x 18.6" x 4.6" (657 mm x 473 mm x 117 mm)
Weight	36.4 lb. (16.5 kg) NET	

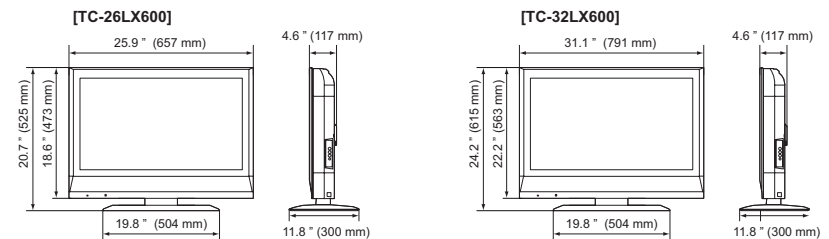

Note

● Design and Specifications are subject to change without notice. Weight and Dimensions shown are approximate.

Limited Warranty (for U.S.A.)

PANASONIC CONSUMER ELECTRONICS COMPANY,
DIVISION OF:
PANASONIC CORPORATION OF NORTH AMERICA
One Panasonic Way
Secaucus, New Jersey 07094

PANASONIC SALES COMPANY,
DIVISION OF:
PANASONIC PUERTO RICO, INC.
Ave. 65 de Infantería, Km. 9.5
San Gabriel Industrial Park
Carolina, Puerto Rico 00985

Panasonic LCD Televisions Limited Warranty

Limited Warranty Coverage

If your product does not work properly because of a defect in materials or workmanship, Panasonic Consumer Electronics Company or Panasonic Sales Company (collectively referred to as "the warrantor") will, for the length of the period indicated on the chart below, which starts with the date of original purchase ("warranty period"), at its option either (a) repair your product with new or refurbished parts, or (b) replace it with a new or a refurbished product. The decision to repair or replace will be made by the warrantor.

LCD TV CATEGORIES	PARTS	LABOR	SERVICE
Up to 20" (diagonal)	1 (ONE) YEAR	1 (ONE) YEAR	Carry-In or Mail-in
21" (diagonal) and larger			In Home or Carry-in / Mail in

During the "Labor" warranty period there will be no charge for labor. During the "Parts" warranty period, there will be no charge for parts. You must carry-in or mail-in your product during the warranty period. If non-rechargeable batteries are included, they are not warranted. This warranty only applies to products purchased and serviced in the United States or Puerto Rico. This warranty is extended only to the original purchaser of a new product which was not sold "as is". A purchase receipt or other proof of the original purchase date is required for warranty service.

In-Home or Carry-in Service

For In-Home or Carry-In Service in the United States call 1-800-211-PANA(7262) or visit the Panasonic web Site: <http://www.panasonic.com>.

For assistance in Puerto Rico call Panasonic Sales Company (787)-750-4300 or fax (787)-768- 2910.

In-Home service requires clear, complete and easy access to the product by the authorized servicer and does not include removal or re-installation of an installed product. It is possible that certain in-home repairs will not be completed in-home, but will require that the product, or parts of the product, be removed for shop diagnosis and/or repair and then returned.

Limited Warranty Limits And Exclusions

This warranty ONLY COVERS failures due to defects in materials or workmanship, and DOES NOT COVER normal wear and tear or cosmetic damage, nor does it cover markings or retained images on the LCD panel resulting from viewing fixed images (including, among other things, letterbox pictures on standard 4:3 screen TV's, or non-expanded standard 4:3 pictures on wide screen TV's, or onscreen data in a stationary and fixed location). The warranty ALSO DOES NOT COVER damages which occurred in shipment, or failures which are caused by products not supplied by the warrantor, or failures which result from accidents, misuse, abuse, neglect, bug infestation, mishandling, misapplication, alteration, faulty installation, set-up adjustments, misadjustment of consumer controls, improper maintenance, power line surge, lightning damage, modification, or commercial use (such as in a hotel, office, restaurant, or other business), rental use of the product, service by anyone other than a Factory Servicenter or other Authorized Servicer, or damage that is attributable to acts of God.

THERE ARE NO EXPRESS WARRANTIES EXCEPT AS LISTED UNDER "LIMITED WARRANTY COVERAGE". THE WARRANTOR IS NOT LIABLE FOR INCIDENTAL OR CONSEQUENTIAL DAMAGES RESULTING FROM THE USE OF THIS PRODUCT, OR ARISING OUT OF ANY BREACH OF THIS WARRANTY. (As examples, this excludes damages for lost time, cost of having someone remove or re-install an installed unit if applicable, or travel to and from the servicer. The items listed are not exclusive, but are for illustration only.) **ALL EXPRESS AND IMPLIED WARRANTIES, INCLUDING THE WARRANTY OF MERCHANTABILITY, ARE LIMITED TO THE PERIOD OF THE LIMITED WARRANTY.**

Some states do not allow the exclusion or limitation of incidental or consequential damages, or limitations on how long an implied warranty lasts, so the exclusions may not apply to you.

This warranty gives you specific legal rights and you may also have others rights which vary from state to state. If a problem with this product develops during or after the warranty period, you may contact your dealer or Servicenter. If the problem is not handled to your satisfaction, then write to the warrantor's Consumer Affairs Department at the addresses listed for the warrantor.

PARTS AND SERVICE (INCLUDING COST OF AN IN-HOME SERVICE CALL, WHERE APPLICABLE) WHICH ARE NOT COVERED BY THIS LIMITED WARRANTY ARE YOUR RESPONSIBILITY.

Customer Services Directory (for U.S.A.)

Customer Services Directory

Obtain Product Information and Operating Assistance; locate your nearest Dealer or Servicenter; purchase Parts and Accessories; or make Customer Service and Literature requests by visiting our Web Site at: <http://www.panasonic.com/consumersupport>

or, contact us via the web at:

<http://www.panasonic.com/contactinfo>

You may also contact us directly at:

1-800-211-PANA (7262)

Monday-Friday 9 am-9 pm; Saturday-Sunday 10 am-7 pm, EST.

■ For hearing or speech impaired TTY users, TTY : 1-877-833-8855

Accessory Purchases

Purchase Parts, Accessories and Instruction Books on line for all Panasonic Products by visiting our Web Site at:

<http://www.pasc.panasonic.com>

or, send your request by E-mail to:

npcparts@us.panasonic.com

You may also contact us directly at:

1-800-332-5368 (Phone) 1-800-237-9080 (Fax Only) (Monday - Friday 9 am to 8 pm, EST.)

Panasonic Services Company

20421 84th Avenue South,

Kent, WA 98032

(We Accept Visa, MasterCard, Discover Card, American Express, and Personal Checks)

■ For hearing or speech impaired TTY users, TTY : 1-866-605-1277

Service in Puerto Rico

Panasonic Puerto Rico, Inc.
Ave. 65 de Infantería, Km. 9.5, San Gabriel Industrial Park,
Carolina, Puerto Rico 00985
Phone (787)750-4300, Fax (787)768-2910

Limited Warranty (for Canada)

Note

Panasonic Canada Inc.

PANASONIC PRODUCT - LIMITED WARRANTY

Panasonic Canada Inc. warrants this product to be free from defects in material and workmanship and agrees to remedy any such defect for a period as stated below from the date of original purchase.

Plasma TV / Monitor	In-home service	One (1) year, parts (including Plasma Panel) and labour.
LCD TV (26 in & over)	In-home service	One (1) year, parts (including LCD Panel) and labour.
LCD TV (25 in & under)	Carry-in service only	One (1) year, parts (including LCD Panel) and labour.

In-home Service will be carried out only to locations accessible by roads and within 50 km of an authorized Panasonic service facility.

LIMITATIONS AND EXCLUSIONS

This warranty does not apply to products purchased outside Canada or to any product which has been improperly installed, subjected to usage for which the product was not designed, misused or abused, damaged during shipping, or which has been altered or repaired in any way that affects the reliability or detracts from the performance, nor does it cover any product which is used commercially. Dry cell batteries are also excluded from coverage under this warranty.

This warranty is extended to the original end user purchaser only. A purchase receipt or other proof of date of original purchase is required before warranty service is performed.

THIS EXPRESS, LIMITED WARRANTY IS IN LIEU OF ALL OTHER WARRANTIES, EXPRESS OR IMPLIED, INCLUDING ANY IMPLIED WARRANTIES OF MERCHANTABILITY AND FITNESS FOR A PARTICULAR PURPOSE. IN NO EVENT WILL PANASONIC CANADA INC. BE LIABLE FOR ANY SPECIAL, INDIRECT OR CONSEQUENTIAL DAMAGES.

In certain instances, some jurisdictions do not allow the exclusion or limitation of incidental or consequential damages, or the exclusion of implied warranties, so the above limitations and exclusions may not be applicable.

In-home service requires clear, complete and easy access to the product by the Authorized Servicentre and does not include removal or re-installation of an installed product. If removal is required to service the product, it will be at the discretion of the Servicentre and in no event will Panasonic Canada Inc. or the Servicentre be liable for any special, indirect or consequential damages.

WARRANTY SERVICE

For product operation and information assistance, please contact:

Our Customer Care Centre: Telephone #: (905) 624-5505
1-800 #: 1-800-561-5505
Fax #: (905) 238-2360
Email link: "Customer support" on www.panasonic.ca

FOR PRODUCT REPAIRS, please locate your nearest Authorized Servicentre at www.panasonic.ca :

Link: "Servicentres™ locator" under "Customer support"

IF YOU SHIP THE PRODUCT TO A SERVICENTRE

Carefully pack and send prepaid, adequately insured and preferably in the original carton. Include details of the defect claimed, and proof of date of original purchase.

Dotted lines for writing on page 50.

Dotted lines for writing on page 51.